

- IHTSDO delivering
- SNOMED CT®
- the global clinical terminology



SNOMED CT Starter Guide

JULY 2014

Version: 2014-07-31
Status: Third release (US)
© Copyright 2014 IHTSDO

Check for the latest version of this guide at www.snomed.org/starterguide.pdf



TABLE OF CONTENTS

1.	Introduction	3
2.	SNOMED CT Benefits	4
3.	Using SNOMED CT in Clinical Information	6
4.	SNOMED CT Basics	9
5.	SNOMED CT Logical Model	14
6.	SNOMED CT Concept Model	20
7.	SNOMED CT Expressions.....	27
8.	SNOMED CT Implementation	34
9.	Content Development	38
10.	Extension and Customization	40
11.	Translations and Language Preferences	44
12.	Mapping	46
13.	Release Schedule and File Formats.....	51
14.	IHTSDO – The Organisation Behind SNOMED CT	53
15.	Learning More About SNOMED CT	56

The SNOMED CT Starter Guide is a publication of the International Health Standards Development Organisation (IHTSDO), the association that owns and maintains SNOMED Clinical Terms. IHTSDO acknowledges the work undertaken by Anne Randorff Højen and Robyn Kuropatwa in preparing this guide as an assignment during their participation in the SNOMED CT Implementation Advisor (SIA) scheme.

© Copyright 2014 International Health Terminology Standards Development Organisation (IHTSDO), all rights reserved.

SNOMED, SNOMED CT and IHTSDO are registered trademarks of the International Health Standards Development Organisation. SNOMED CT licensing information is available at www.ihtsdo.org/licensing. For more information about IHTSDO and IHTSDO Membership, please refer to www.ihtsdo.org or contact us at info@ihtsdo.org.

The July 2014 version contains minor corrections and clarifications addressing comments made on the first version published in January 2014 and revised in February 2014. Future updates of this and other documents will be accessible from the document library at www.snomed.org/doc.





1. INTRODUCTION

Goals and objectives

The vision for the SNOMED Clinical Terms (SNOMED CT) Starter Guide is for it to be a practical and useful starting point from which anyone with a general interest in healthcare information can begin learning about SNOMED CT.

Target audience

The target audience for this Starter Guide includes people from various disciplines who may be involved at any point in the SNOMED CT information management cycle – from initial planning, clinical content definition and implementation through to use of the resulting clinical information. This spans people involved with planning and deciding to proceed and resource a SNOMED CT implementation, people involved in reference set development, terminology management, technical implementation and all aspects of deployment and use. It also includes people involved in clinical information retrieval, analyses, decision support and other aspects of knowledge representation. The characteristics common to all members of the target audience are that they have a reason for wanting to understand SNOMED CT and are seeking a high-level initial overview of topics of which they need to be aware. The Starter Guide does not provide in depth knowledge but does provide an informative and authoritative foundation on which to build.

Topics

The topics covered in this SNOMED CT Starter Guide include:

- ◆ SNOMED CT Benefits
- ◆ Using SNOMED CT in Clinical Information
- ◆ SNOMED CT Basics
- ◆ SNOMED CT Logical Model
- ◆ SNOMED CT Concept Model
- ◆ SNOMED CT Expressions
- ◆ Content Development
- ◆ Extension and Customization
- ◆ Translations and Language Preferences
- ◆ Mapping
- ◆ Release Schedule and File Formats
- ◆ Implementation
- ◆ IHTSDO
- ◆ Learning More

For each topic the questions addressed include:

- ◆ Why is this important?
- ◆ What is this?

Supporting references are included in the final chapter of the guide.

2. SNOMED CT BENEFITS

This section provides an overview of how effective use of SNOMED CT:

- ◆ Benefits populations
- ◆ Benefits individual patients and clinicians
- ◆ Supports evidence based healthcare

Why is this important?

Understanding the benefits of SNOMED CT will inform key decisions and the development of strategies for adoption, implementation and use of this clinical terminology.

What is this?

SNOMED CT supports the development of comprehensive high-quality clinical content in health records. It provides a standardized way to represent clinical phrases captured by the clinician and enables automatic interpretation of these. SNOMED CT is a clinically validated, semantically rich, controlled vocabulary that facilitates evolutionary growth in expressivity to meet emerging requirements.

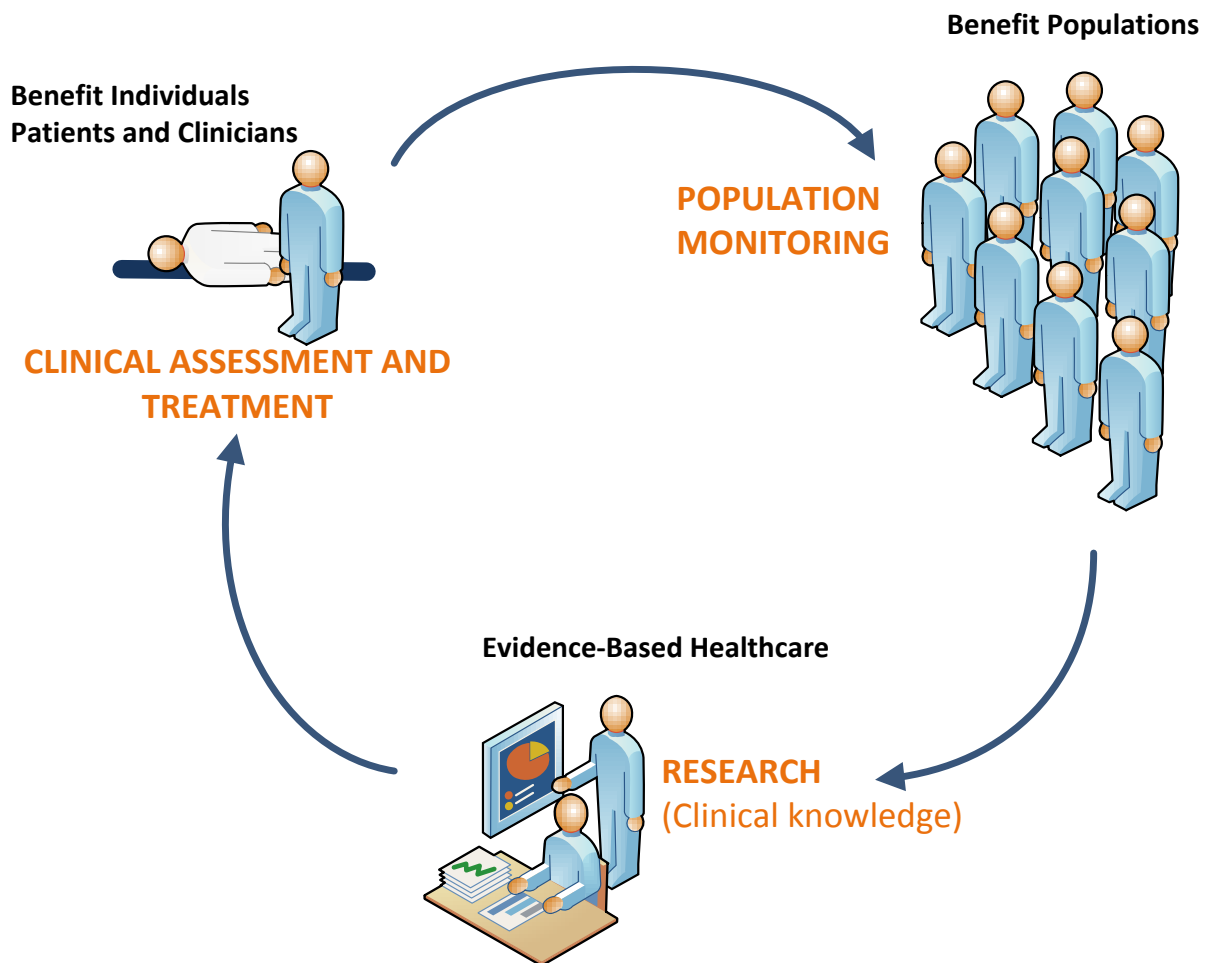



Electronic Health Records

SNOMED CT based clinical information benefits individual patients and clinicians as well as populations and it supports evidence based care.

The use of an Electronic Health Record (EHR) improves communication and increases the availability of relevant information. If clinical information is stored in ways that allow meaning-based retrieval, the benefits are greatly increased. The added benefits range from increased opportunities for real time decision support to more accurate retrospective reporting for research and management.

SNOMED CT Enabled Health Records Benefit Individuals

SNOMED CT enabled clinical health records benefit individuals by:

- ◆ Enabling relevant clinical information to be recorded using consistent, common representations during a consultation.
- ◆ Enabling guideline and decision support systems to check the record and provide real-time advice, for example, through clinical alerts.
- ◆ Supporting the sharing of appropriate information with others involved in delivering care to a patient through data capture that allows understanding and interpretation of the information in a common way by all providers.
- ◆ Allowing accurate and comprehensive searches that identify patients who require follow-up or changes of treatment based on revised guidelines.
- ◆ Removing language barriers (SNOMED CT enables multilingual use).

SNOMED CT Enabled Health Records Benefit Populations

SNOMED CT enabled clinical health records benefit populations by:

- ◆ Facilitating early identification of emerging health issues, monitoring of population health and responses to changing clinical practices.
- ◆ Enabling accurate and targeted access to relevant information, reducing costly duplications and errors.
- ◆ Enabling the delivery of relevant data to support clinical research and contribute evidence for future improvements in treatment.
- ◆ Enhancing audits of care delivery with options for detailed analysis of clinical records to investigate outliers and exceptions.

SNOMED CT Enabled Health Records Support Evidence-Based Healthcare

SNOMED CT enabled health records inform evidence based health care decisions by:

- ◆ Enabling links between clinical records and enhanced clinical guidelines and protocols.
- ◆ Enhancing the quality of care experienced by individuals.
- ◆ Reducing costs of inappropriate and duplicative testing and treatment.
- ◆ Limiting the frequency and impact of adverse healthcare events.
- ◆ Raising the cost-effectiveness and quality of care delivered to populations.

3. USING SNOMED CT IN CLINICAL INFORMATION

This section provides an overview of:

- ◆ How SNOMED CT supports reuse of clinical information
- ◆ Extent of practical use
- ◆ Approaches to implementation
- ◆ Lessons learnt
- ◆ Challenges

Why is this important?

The objective of IHTSDO and all users of SNOMED CT is to facilitate the accurate recording and sharing of clinical and related health information and the semantic interoperability of health records.

What is this?

How SNOMED CT supports reuse of clinical information

SNOMED CT is a clinical terminology with global scope covering a wide range of clinical specialties, disciplines and requirements. As a result of its broad scope, one of the benefits of SNOMED CT is a reduction of specialty boundary effects that arise from use of different terminologies or coding systems by different clinicians or departments. This allows wider sharing and reuse of structured clinical information. Another benefit of SNOMED CT is that the same data can be processed and presented in ways that serve different purposes. For example, clinical records represented using SNOMED CT can be processed and presented in different ways to support direct patient care, clinical audit, research, epidemiology, management and service planning. Additionally, the global scope of SNOMED CT reduces geographical boundary effects arising from the use of different terminologies or coding systems in different organizations and countries.

With SNOMED CT, clinical information is recorded using identifiers that refer to concepts that are formally defined as part of the terminology. SNOMED CT supports recording of clinical information at appropriate levels of detail using relevant clinical concepts. The structures of SNOMED CT allow information to be entered using synonyms that suit local preferences while recording the information in a consistent and comparable form. Additionally, the hierarchical nature of SNOMED CT permits information to be recorded with different levels of detail to suit particular uses (e.g. |pneumonia|, |bacterial pneumonia| or |pneumococcal pneumonia|). SNOMED CT allows additional detail to be added by combining concepts where the available concepts are not sufficiently precise (e.g. |pneumococcal pneumonia| with a |finding site| of |right upper lobe of lung|).

SNOMED CT allows a range of different options for immediate retrieval and subsequent reuse to address immediate and longer term clinical requirements and the requirements of other users. The nature of SNOMED CT hierarchies allow information to be selectively retrieved and reused to meet different requirements at various levels of generalization (e.g. retrieval of subtypes of |lung disorder| or |bacterial infection| would both include |bacterial pneumonia|).

The SNOMED CT concept model also allows additional details to be considered when retrieving data. For example, the concept |pneumococcal pneumonia| is a subtype of |bacterial pneumonia| which has a defining relationship that specifies that the |causative agent| is |streptococcus pneumoniae| and this allows the organism causing this disease to be analyzed.

Extent of practical use

Many systems use SNOMED CT to represent some types of clinical information. The extent of use is varied in terms of:

- ◆ The clinical content captured (i.e. what is included and what is not).
- ◆ How the structure of this content relates to the structures in the records.
- ◆ The scope and consistency of use and reuse (i.e. within and across national and local organizations, across departments, within proprietary applications or specifically configured instances of proprietary applications).

Approaches to implementation

SNOMED CT has been implemented in a variety of ways which differ in the extent to which they harness particular features of the terminology. In some cases, these differences merely reflect the specific requirements of a particular use. Other factors include the design of existing systems prior to the introduction of SNOMED CT, sophistication of available technology and support for a range of other health informatics standards.

Key determinants for effective benefits realization include:

- ◆ Representation of stored clinical information.
 - To enable effective reuse of clinical information, SNOMED CT should be used within a record structure (or information model) that stores similar information consistently and in ways that can be readily queried.
- ◆ Ease of data entry
 - Different approaches to data entry are valuable and may be mediated in a variety of ways to enable ease of data entry.
 - The method of data entry should not result in inconsistent representations of the same types of clinical information.
 - The most effective approaches constrain data entry specific to the clinical context and reason for use.
 - Unconstrained searches across the entire content of SNOMED CT are rarely appropriate for routine data entry.
 - Constraints that limit data entry to a fixed set of SNOMED CT concepts are useful where the clinical context and reasons for use are narrow.
 - Constraints that alter dynamically to meet requirements of a particular data entry context offer a more generalizable approach that can be configured to meet different requirements.
 - Natural Language Processing (NLP) to parse and tag text with SNOMED CT expressions has been found useful in some applications.

- ◆ Communication
 - Communication interfaces, including message structures, need to be designed to retain the common elements of clinical content structure and coding. Communication should enable the receiving system to reuse the clinical information effectively based on the SNOMED CT expressions within it.
- ◆ Retrieval, analysis and reuse
 - Record storage and indexing can be designed to optimize use of the semantic features of SNOMED for selective retrieval and to support flexible analytics.
 - Retrieval in the patient care setting should result in the display of clinical records including highlighting of critical information selected taking account of the computer processable expressivity of SNOMED CT.
 - Real time decision support ranges from simple flagging of contraindications to guidelines for investigation and management.
 - Batch mode decision support identifies patients with chronic diseases and risk factors who require recalls for review and other scheduled interventions.
 - Analysis of data can be completed for selected populations of patients for a variety of purposes including audit, service planning, epidemiology and clinical research.

Lessons learnt

The features of SNOMED CT support reusability of clinical information. However, reusability also requires a consistent structured representation of clinical information that complements the meaning supported by SNOMED CT. Without this, overlaps and conflicts between structural and terminological representations of clinical content can result in ambiguous and potentially conflicting interpretations.

The way in which the use of terminology and structure together contribute to the representation of meaningful information is sometimes referred to as the “model of meaning”. To enable widespread clinical information reuse, queries need to be consistently formulated in ways that take account of the way the information is structured and coded. A common model of meaning facilitates widespread reuse of clinical information, ability to reuse queries and a consistent approach to linkage between clinical information and knowledge resources.

Human factors may result in inconsistent recording of similar clinical information. This issue can be minimized by effectively constraining data entry.

Challenges

An important limitation is the diversity of views related to the structure of clinical information and the overlap between information models and terminology. There are also differing views on application design, different requirements for collection of clinical information and different views on record structures and data entry methods appropriate to different use cases.

IHTSDO is working with other standards bodies including the International Organisation for Standardisation (ISO) and Health Level 7 (HL7), as well as various collaborative efforts exploring the relationship between terminology and structured clinical information. The objective is to ensure that the role of SNOMED CT as a key component of clinical information and systems is understood as part of overall efforts towards harmonization and interoperability.



4. SNOMED CT BASICS

This section provides an overview of:

- ◆ SNOMED CT features
- ◆ Exploring SNOMED CT
- ◆ SNOMED CT design and development
- ◆ SNOMED CT components and hierarchies
- ◆ SNOMED CT characteristics
- ◆ SNOMED CT supporting different languages
- ◆ SNOMED CT products and services

Why is this important?

An awareness of SNOMED CT features, components, characteristics and products provides an initial foundation on which to build greater understanding. It also informs discussions leading to decisions about adoption, implementation and use of this terminology.

What is this?

SNOMED CT features

SNOMED CT:

- ◆ Is the most comprehensive, multilingual clinical healthcare terminology in the world.
- ◆ Is a resource with comprehensive, scientifically validated clinical content.
- ◆ Enables consistent, processable representation of clinical content in electronic health records.
- ◆ Is mapped to other international standards.
- ◆ Is already used in more than fifty countries.

When implemented in software applications, SNOMED CT can be used to represent clinically relevant information consistently, reliably and comprehensively as an integral part of producing electronic health information.

Implementation requires an understanding of the way that SNOMED CT content is represented by Components and supported by Reference Sets (Refsets).

Exploring SNOMED CT

While reading the guide, you may find it useful to explore the content of SNOMED CT. You can do this using one of a range of online browsers listed on our web site at www.snomed.org/browsers. Note that the listed browsers are not endorsed by IHTSDO and they should only be used to get a feel for the content and structure of the terminology. It is useful to experiment with several different browsers as they vary in the way they present particular features of the terminology.

SNOMED CT design and development

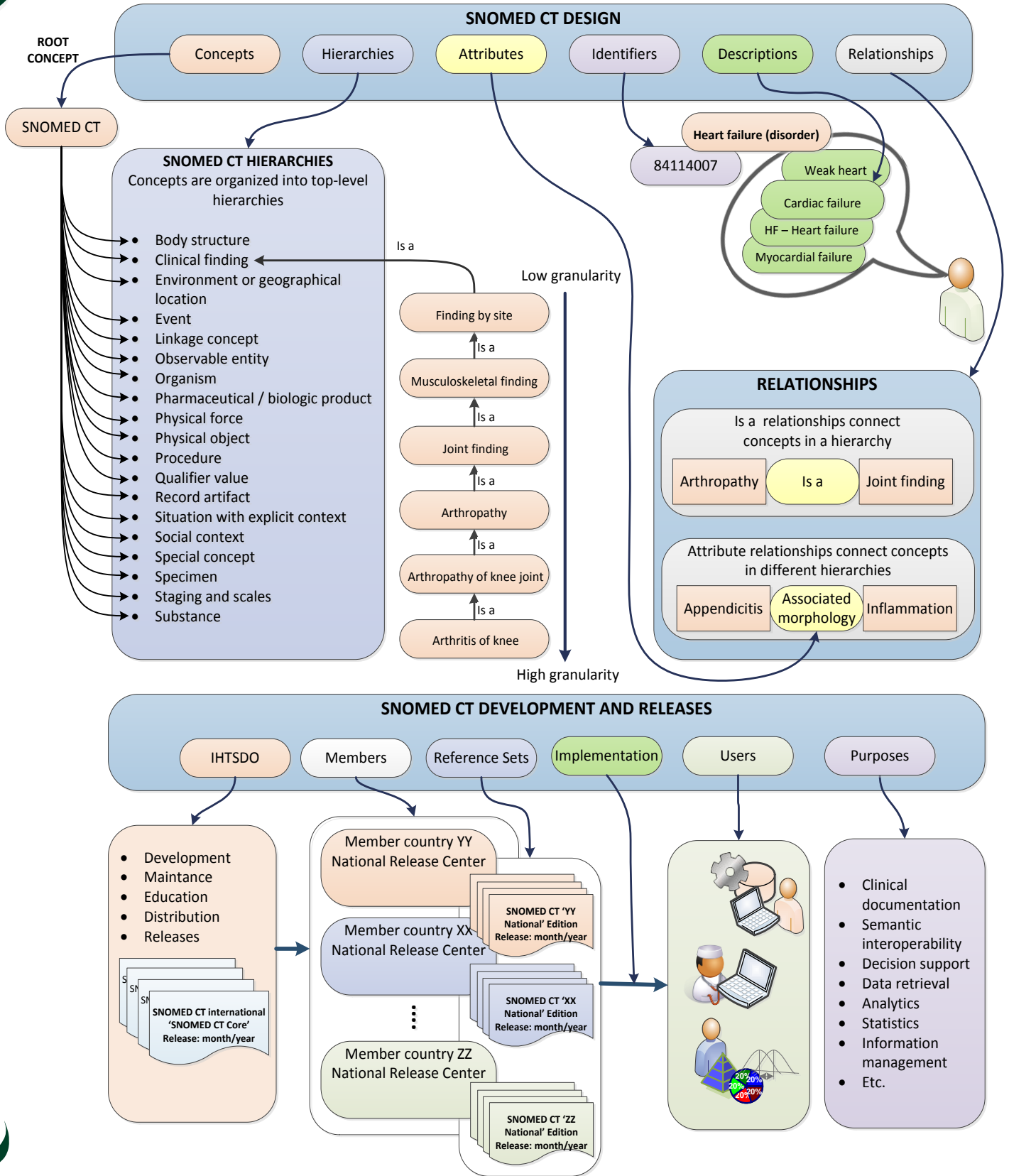

SNOMED CT Components

SNOMED CT is a core clinical healthcare terminology that contains concepts with unique meanings and formal logic based definitions organized into hierarchies.

SNOMED CT content is represented using three types of component:

- ◆ Concepts representing clinical meanings that are organized into hierarchies.
- ◆ Descriptions which link appropriate human readable terms to concepts.
- ◆ Relationships which link each concept to other related concepts.

These components are supplemented by Reference Sets, which provide additional flexible features and enable configuration of the terminology to address different requirements.

Concepts

SNOMED CT concepts represent clinical thoughts, ranging from |abscess| to |zygote|. Every concept has a unique numeric concept identifier. Within each hierarchy, concepts are organized from the general to the more detailed. This allows detailed clinical data to be recorded and later accessed or aggregated at a more general level.

Descriptions

SNOMED CT descriptions link appropriate human readable terms to concepts. A concept can have several associated descriptions, each representing a synonym that describes the same clinical concept. Each translation of SNOMED CT includes an additional set of descriptions, which link terms in another language to the same SNOMED CT concepts. Every description has a unique numeric description identifier.

Relationships

SNOMED CT relationships link concepts to other concepts whose meaning is related in some way. These relationships provide formal definitions and other properties of the concept. One type of relationship is the |is a| relationship which relates a concept to more general concepts. These |is a| relationships define the hierarchy of SNOMED CT concepts.

- ◆ For example, the concepts |bacterial pneumonia| and |viral pneumonia| both have an |is a| relationship to |infective pneumonia| which has an |is a| relationship to the more general concept |pneumonia|.

Other types of relationships represent aspects of the meaning of a concept.

- ◆ For example, the concept |viral pneumonia| has a |causative agent| relationship to the concept |virus| and a |finding site| relationship to the concept |lung|.

Every relationship has a unique numeric relationship identifier.

Reference sets

Reference sets (Refsets) are a flexible standard approach used by SNOMED CT to support a variety of requirements for customization and enhancement of SNOMED CT. These include the representation of subsets, language preferences for use of particular terms and mapping from or to other code systems. Every reference set has a unique numeric concept identifier.

SNOMED CT hierarchies

SNOMED CT concepts are organized in hierarchies. Within a hierarchy, concepts range from the more general to the more detailed. Related concepts in the hierarchy are linked using the |is a| relationship.

- ◆ Examples of some of the hierarchies include |clinical finding|, |procedure|, |observable entity|, |body structure| and |organism|.

SNOMED CT characteristics - comprehensive, scalable and flexible

SNOMED CT has a broad coverage of health related topics. It can be used to describe a patient's medical history, the details of an orthopedic procedure, the spread of epidemics, and much more. At the same time, the terminology has an unmatched depth, which enables clinicians to record data at the appropriate level of granularity.

Specific applications tend to focus on a restricted set of SNOMED CT, such as concepts related to ophthalmology. These subsets can be used to present relevant parts of the terminology, depending on the clinical context and local requirements. This means for example, that a drop down list to select diagnoses in an electronic health record in a mental health facility can be tailored to that setting. Similarly, subsets can be defined for problem lists for physician specialties or to provide appropriate medication lists for nurses in community care.

When individual jurisdictions have needs beyond those that can be reflected in a global terminology, perhaps due to requirements in local legislation, they can develop local or national extensions. Thus, even though SNOMED CT is global in scope, it can be adapted to each country's or areas requirements.

SNOMED CT maps work to provide explicit links to health related classifications and coding schemes in use around the world, e.g. statistical classifications such as ICD-9-CM, ICD-10, and ICD-O3. Maps to or from several national code systems are also available from, or under development, by IHTSDO Members. Maps to or from clinical domain specific code systems are also maintained by specialty groups with which IHTSDO has collaborative agreement. Maps facilitate reuse of SNOMED CT based clinical data for other purposes, such as reimbursement or statistical reporting.

Supporting different languages

SNOMED CT is a multinational, multilingual terminology. It has a built-in framework to manage different languages and dialects. The International Release includes a set of language independent concepts and relationships. Today, SNOMED CT is available in US English, UK English, Spanish, Danish and Swedish. Partial translations into Canadian French, Lithuanian, and several other languages are currently taking place, and further language translations are being planned by IHTSDO Members.

The basic objective of any SNOMED CT translation is to provide accurate representations of SNOMED CT concepts in a way that is understandable, usable, and safe. Translations must be concept based. Translators need to analyse concepts based on the fully specified name and take account of its position within the hierarchy, its descriptions, and its relationships to other concepts. This enables a meaningful translation of a concept based on phrases that are well used and clearly understood in all countries. The IHTSDO maintains guidelines and other materials to support countries undertaking translations.



SNOMED CT products and services

IHTSDO Members and organizations covered by the SNOMED CT Affiliate License have access to a range of products and services, including:

- ◆ SNOMED CT terminology files consisting of:
 - Concepts
 - Descriptions
 - Relationships
- ◆ Derivative works that help in the uptake and use of SNOMED CT, including Reference Sets that support:
 - Identification of subsets of SNOMED CT content
 - Language or dialect preferences for use of particular descriptions
 - Maps to other code systems and classifications
 - Other relevant metadata to support use of SNOMED CT components.
- ◆ Implementation guidance for successful use of SNOMED CT including:
 - Implementation guidance
 - Translation guidance
 - Editorial guidance for content development
- ◆ Access to services supporting submission of requests for changes or additions to content and documentation.
- ◆ Participation in the global IHTSDO community through an electronic collaborative space and meeting of special interest groups.

5. SNOMED CT LOGICAL MODEL

This section provides an overview of:

- ◆ Logical Model Components – representing the core content of the terminology
- ◆ Reference Sets – configuring and enhancing terminology content

Why is this important?

The SNOMED CT logical model provides the fundamental structure of SNOMED CT and specifies how the components can be managed in an implementation setting to meet a variety of primary and secondary uses.

What is this?

The SNOMED CT logical model defines the way in which each type of SNOMED CT component and derivative is related and represented. The core component types in SNOMED CT are concepts, descriptions and relationships. The logical model therefore specifies a structured representation of the concepts used to represent clinical meanings, the descriptions used to refer to these, and the relationships between the concepts.

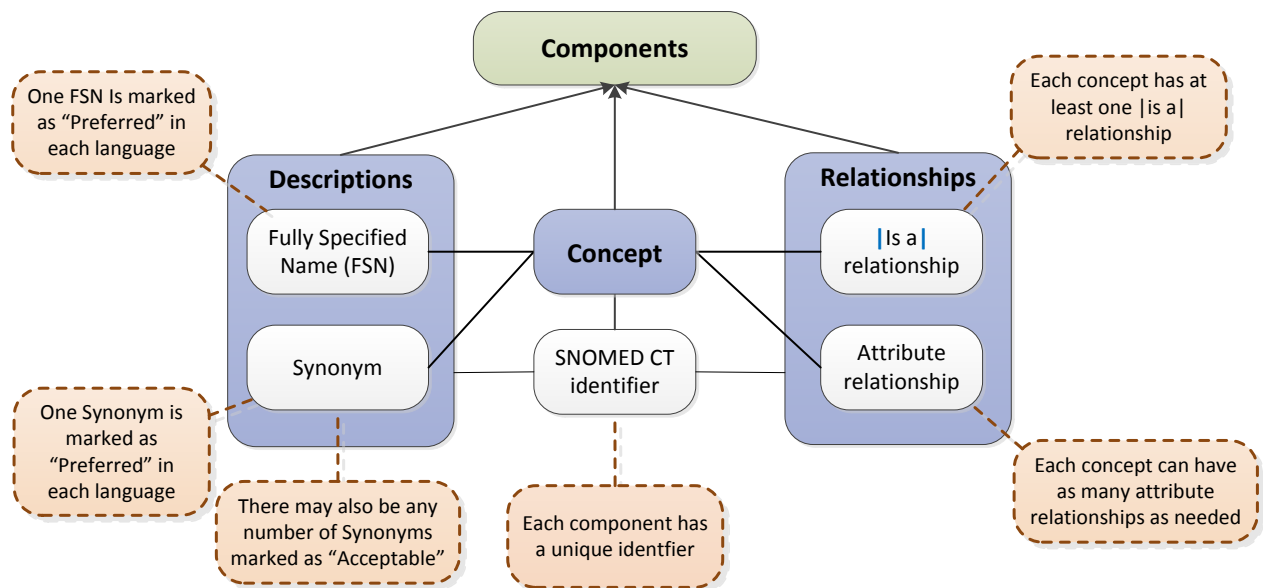

Concepts

Every concept represents a unique clinical meaning, which is referenced using a unique, numeric and machine-readable SNOMED CT identifier. The identifier provides an unambiguous unique reference to each concept and does not have any ascribed human interpretable meaning.

- ◆ Other types of components also have unique identifiers – however, the concept identifier has a specific role as the code used to represent the meaning in clinical records, documents, messages and data.

Descriptions

A set of textual descriptions are assigned to every concept. These provide the human readable form of a concept. Two types of description are used to represent every concept - Fully Specified Name (FSN) and Synonym.

The FSN represents a unique, unambiguous description of a concept's meaning. The FSN is not intended to be displayed in clinical records, but is instead used to disambiguate the distinct meaning of each different concept. This is particularly useful when different concepts are referred to by the same commonly used word or phrase. Each concept can have only one FSN in each language or dialect.

A synonym represents a term that can be used to display or select a concept. A concept may have several synonyms. This allows users of SNOMED CT to use the terms they prefer to refer to a specific clinical meaning. Concepts can have multiple synonyms, and the associated terms are not necessarily unique – thus two concepts can have the same synonym term. Interpretation of a synonymous term therefore depends on the concept identifier.

Each concept has one synonym which is marked as |preferred| in a given language, dialect, or context of use. This is known as the “preferred term” and is a word or phrase commonly used by clinicians to name that concept. In each language, dialect or context of use, one and only one synonym can be marked as |preferred|. Any number of other synonyms that are valid in a language, dialect or context of use can be marked as |acceptable|.

Example of descriptions for a single concept (US - English)

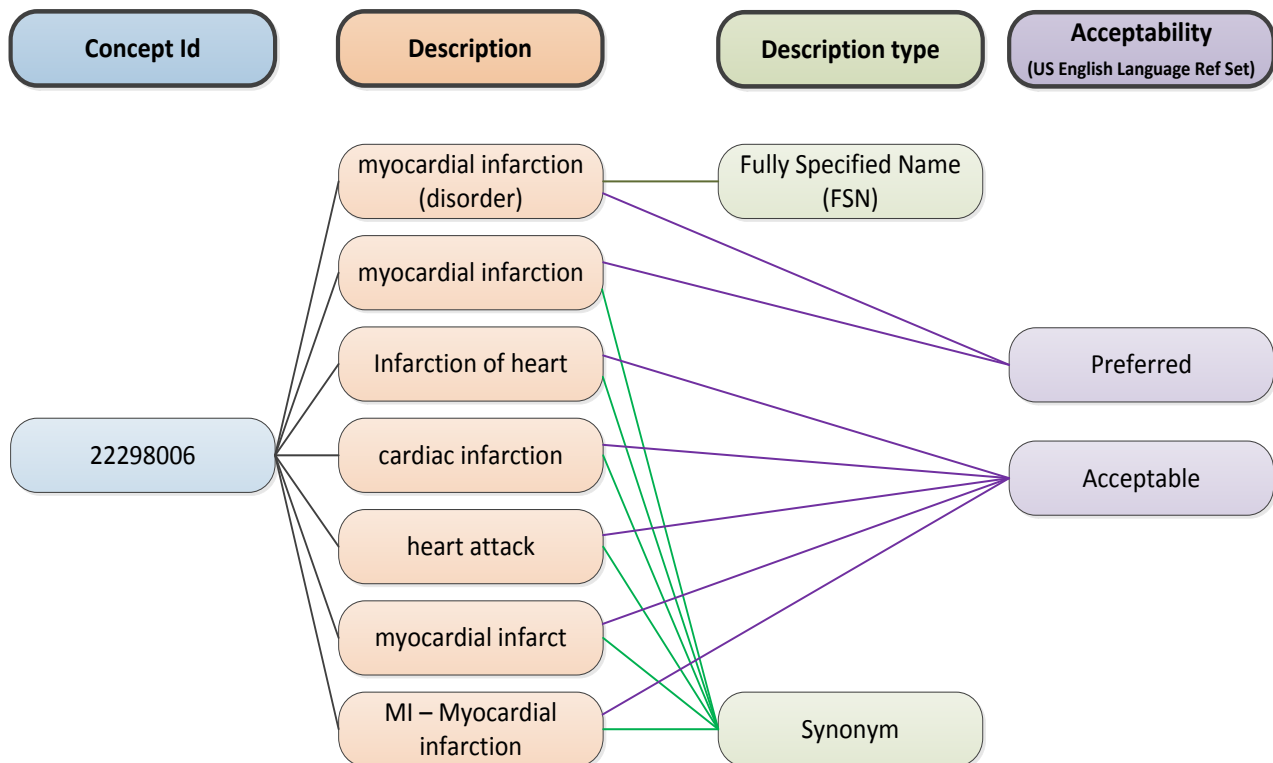

Relationships

A relationship represents an association between two concepts. Relationships are used to logically define the meaning of a concept in a way that can be processed by a computer. A third concept, called a relationship type (or attribute), is used to represent the meaning of the association between the source and destination concepts. There are different types of relationships available within SNOMED CT.

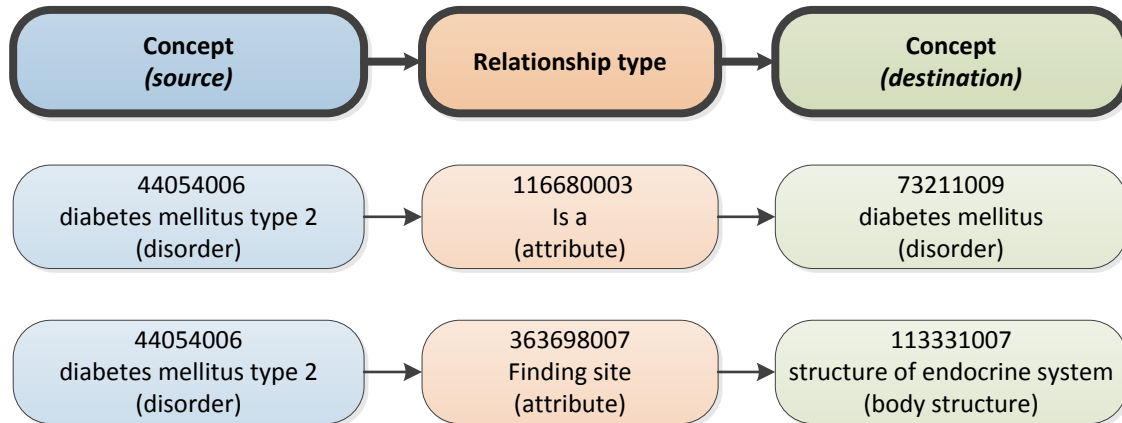

Subtype relationships

Subtype relationships are the most widely used type of relationship. Subtype relationships use the | is a | relationship type and are therefore also known as | is a | relationships. Almost all active SNOMED CT concepts are the source of at least one | is a | relationship. The only exception is the root concept | SNOMED CT Concept | which is the most general concept. The | is a | relationship states that the source concept is a subtype of the destination concept. SNOMED CT relationships are directional and the | is a | relationship read in the reverse direction states that the destination concept is a supertype of the source concept.

Example of | is a | relationships

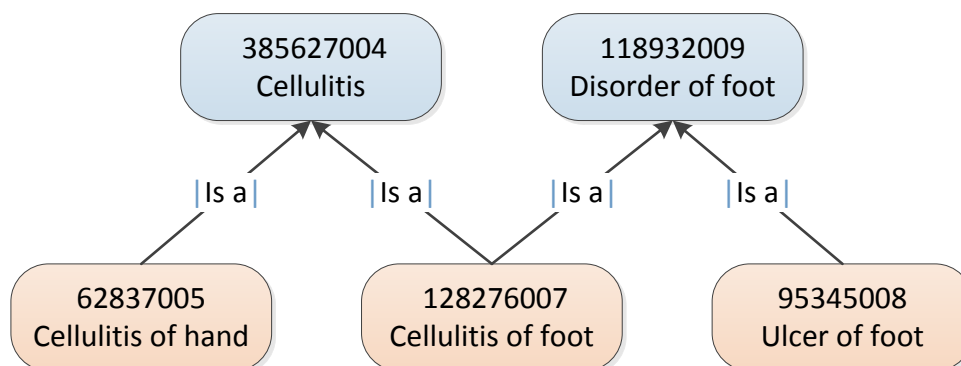

The | is a | relationships form the hierarchies of SNOMED CT. They are therefore also known as hierarchical relationships. The source concept of the | is a | relationship has a more specific clinical meaning than the target concept. This means that the level of clinical detail of the concepts increases with the depth of the hierarchies.

If two concepts are directly linked by a single |is a| relationship, the source concept is said to be a “subtype child” of the destination concept. The destination concept is referred to as a “supertype parent”. Any concept that is the source of a sequence of one or more |is a| relationships leading to a specified destination concept, is a “subtype descendant” of that concept. Similarly, any concept that is the destination of a sequence of one or more |is a| relationships leading to a specified source concept, is a “supertype ancestor” of that concept. It is also said that the source concept of an |is a| relationship “is subsumed by” the target concept, and that the target concept of an |is a| relationship “subsumes” the source concept.

Each concept can have |is a| relationships to several other concepts (i.e. a concept may have multiple supertype parent concepts). As a result the SNOMED CT hierarchy is not a simple tree but has a structure that is known as a “polyhierarchy”.

Illustration of SNOMED CT subtype hierarchy and terms used to describe it

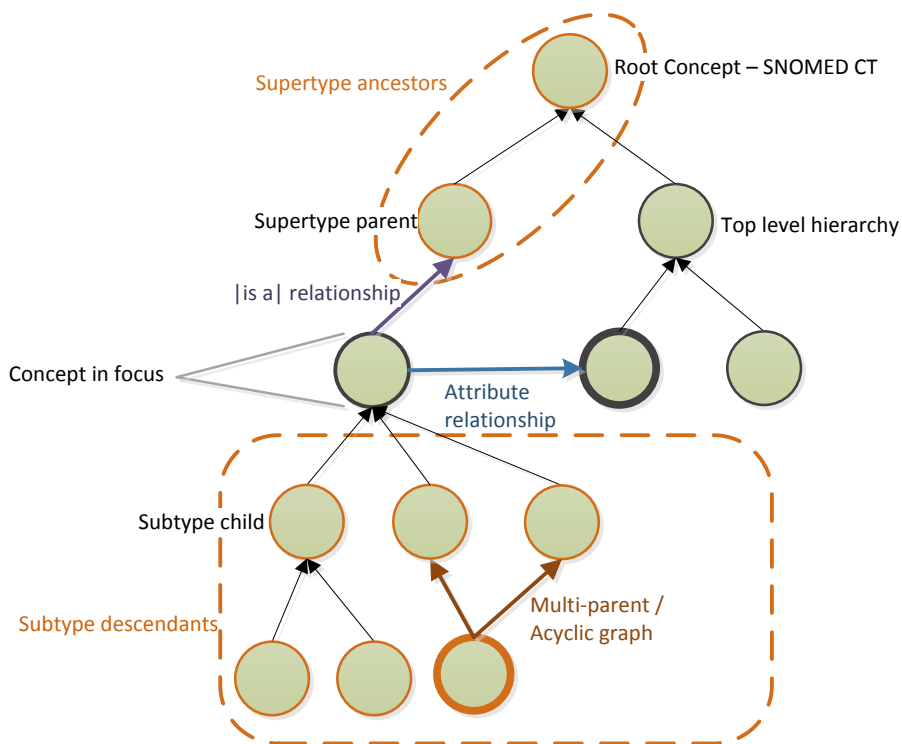

Attribute relationships

An attribute relationship contributes to the definition of the source concept by associating it with the value of a defining characteristic. The characteristic (attribute) is specified by the relationship type and the value is provided by the destination of the relationship.

The following example shows the defining relationships of the concept |abscess of heart|. The attribute relationships |associated morphology| and |finding site| are used to associate the source concept |abscess of heart| to respectively the target concepts |abscess|, and |heart structure|.

Example of defining relationships

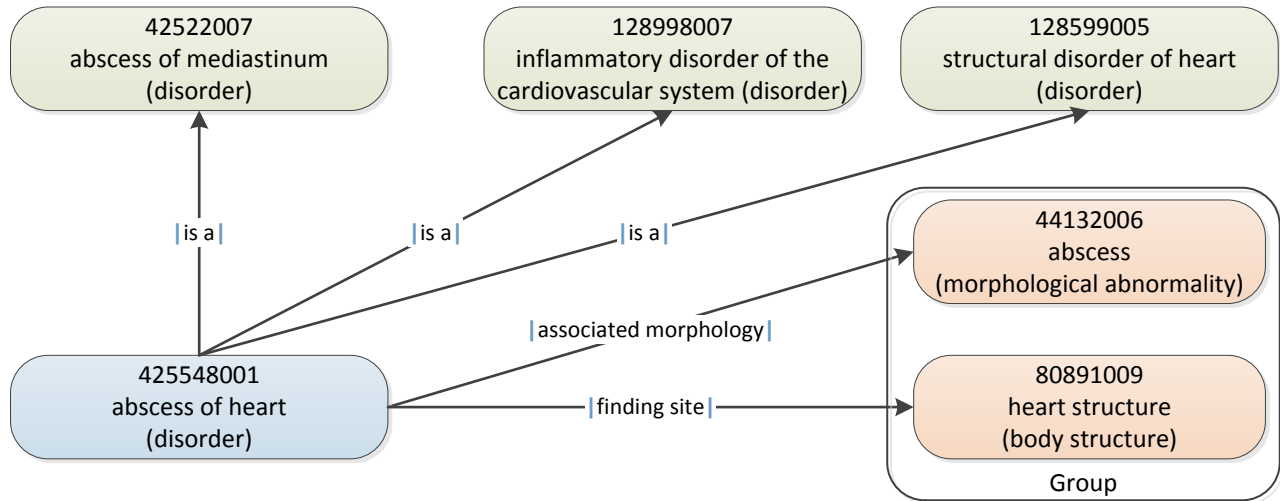

Unlike `| is a |` relationships, which are used to define all concepts, the applicability of each type of attribute relationship is limited to a defined domain and range. The domain refers to the concepts that can serve as source concepts for that type of attribute relationship. The range refers to the concepts that can serve as destinations (values) for those attributes. The domain and range specification ensure consistent definitions that can be used to infer additional semantic relationships to deliver reliable meaning-based retrieval of the composed meanings.

The first example below violates the domain constraint of `| causative agent |`, as descendants of `| body structure |` are not in the domain of `| causative agent |`. The second example below is valid with respect to the domain constraint of `| causative agent |`, because `| disorder |` is in the domain of `| causative agent |`. However, this example violates the range constraint of `| causative agent |`, as descendants of morphological abnormality are not in the range of `| causative agent |`.

Example of erroneous relationships

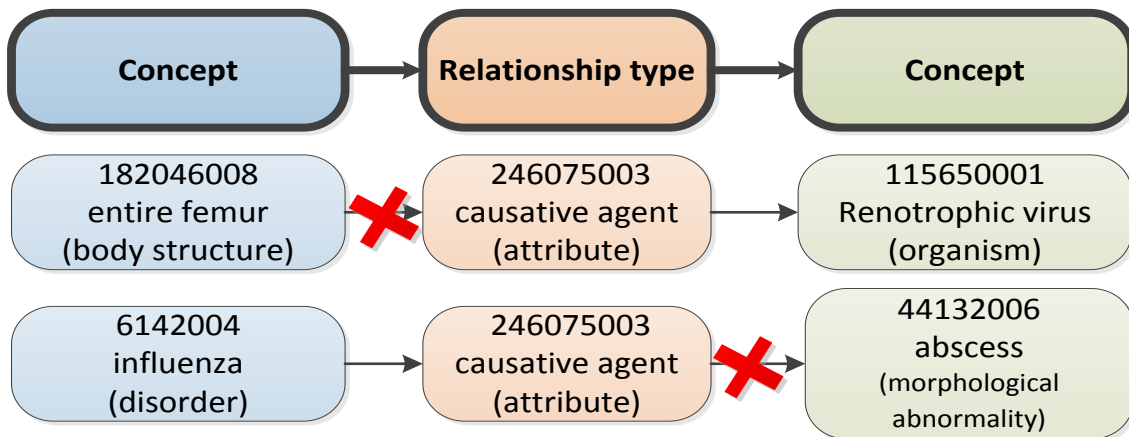



Fully defined and primitive concepts

In SNOMED CT every concept is specified as either fully defined or primitive.

A concept is *fully-defined* if its defining characteristics are sufficient to distinguish its meaning from other similar concepts. One example is that the concept |acute disease| is *fully-defined* by its two defining relationships. The first relationship is |is a| |disease| and the second relationship is |clinical course| |sudden onset AND/OR short duration|. Stating that this concept is *fully-defined* means that any concept that |is a| |disease| and has a |clinical course| of |sudden onset AND/OR short duration| is a subtype of this concept (or the concept itself).

A concept is *primitive* (not fully-defined) if its defining characteristics are not sufficient to uniquely distinguish its meaning from other similar concepts. One example is that the primitive concepts |disease| and |drug action| share the same defining characteristics: namely a relationship of type |is a| to the concept |clinical finding|. This is despite the fact that the concepts |disease| and |drug action| represent different clinical ideas.

Reference sets

Reference Sets (Refsets) are a standard way to represent additional non-defining information about members of a set of components. Reference Sets are important as they can be used in SNOMED CT enabled applications to constrain, configure and enhance functionality to match requirements for different use cases. Some examples of the many uses of reference sets are to represent:

- ◆ **Language and dialect preferences** for use of particular terms to describe a concept. Language Reference Sets allow the preferred and acceptable descriptions to be configured for a language, dialect or context of use.
- ◆ **Subsets of components that are included in or excluded** from the set of values that can be used in a particular country, Organisation, specialty or context.
- ◆ **Value sets of concepts** limiting the permitted content of a field in line with requirements of standard message or communication interface.
- ◆ **Frequently used descriptions or concepts** that can be prioritized for searches in a particular country, Organisation, specialty or context.
- ◆ **Structuring and ordering of lists and hierarchies** to display concepts in convenient structured lists or tree-view controls to assist entry of particular data items.
- ◆ **Maps to or from other code systems** the maps supported by Reference Sets includes simple one-to-one maps and more complex maps requiring human-readable advice or machine processable rules to resolve ambiguities.

6. SNOMED CT CONCEPT MODEL

This section provides an overview of:

- ◆ Concept Model – Top Level Hierarchies
- ◆ Concept Model Attributes – Representing Characteristics of a Concept

Why is this important?

The SNOMED CT concept model specifies the way in which SNOMED CT concepts are defined using a combination of formal logic and editorial rules. Concept model rules specify the top level concepts under which concepts are arranged in the subtype hierarchy and the types of relationships that are permitted between concepts in particular branches of the hierarchy.

What is this?

Concept model – top level hierarchies

The top of the SNOMED CT hierarchy is occupied by the root concept (|SNOMED CT concept|). All concepts are descended from this root concept through at least one sequence of |is a| relationships. This means that the root concept is a supertype of all other concepts and all other concepts are subtypes of the root concept.

The direct subtypes of the root concept are referred to as ‘Top Level Concepts’. These concepts are used to name the main branches of the hierarchy. Each of these Top Level Concepts, together with their many subtype descendants, forms a major branch of the SNOMED CT hierarchy and contains similar types of concepts. As the hierarchies descend (that is, more |is a| relationships are added below the Top Level Concepts) the concepts within them become increasingly specific.

Below is a list of the Top Level Concepts with a brief description of the content represented in their branch of the hierarchy.

|Clinical finding| represents the result of a clinical observation, assessment or judgment and includes normal and abnormal clinical states (e.g. |asthma|, |headache|, |normal breath sounds|). The |clinical finding| hierarchy includes concept used to represent diagnoses.

|Procedure| represents activities performed in the provision of health care. This includes not only invasive procedures but also administration of medicines, imaging, education, therapies and administrative procedures (e.g. |appendectomy|, |physiotherapy|, |subcutaneous injection|).

|Situation with explicit context| represents concepts in which the clinical context is specified as part of the definition of the concept itself. These include presence or absence of a condition, whether a clinical finding is current, in the past or relates to someone other than the subject of the record (e.g. |endoscopy arranged|, |past history of myocardial infarction|, |family history of glaucoma|).

|Observable entity| represents a question or assessment which can produce an answer or result (e.g. |systolic blood pressure|, |color of iris|, |gender|).

|Body structure| represents normal and abnormal anatomical structures (e.g. |mitral valve structure|, |adenosarcoma|).

|Organism| represents organisms of significance in human and animal medicine (e.g. |streptococcus pyogenes|, |beagle|, |texon cattle breed|).

|Substance| represents general substances, the chemical constituents of pharmaceutical/biological products, body substances, dietary substances and diagnostic substances (e.g. |methane|, |insulin|, |albumin|).

|Pharmaceutical / biologic product| represents drug products (e.g. |amoxicillin 250mg capsule|, |paracetamol + codeine tablet|).

|Specimen| represents entities that are obtained (usually from the patient) for examination or analysis (e.g. |urine specimen|, |prostate needle biopsy specimen|).

|Special concept| represents concepts that do not play a part in the formal logic of the concept model of the terminology, but which may be useful for specific use cases (e.g. |navigational concept|, |alternative medicine poisoning|).

|Physical object| represents natural and man-made physical objects (e.g. |vena cava filter|, |implant device|, |automobile|).

|Physical force| represents physical forces that can play a role as mechanisms of injury (e.g. |friction|, |radiation|, |alternating current|).

|Event| represents occurrences excluding procedures and interventions (e.g. |flood|, |earthquake|).

|Environments and geographical locations| represents types of environments as well as named locations such as countries, states and regions (e.g. |intensive care unit|, |academic medical center|, |Denmark|).

|Social context| represents social conditions and circumstances significant to health care (e.g. |occupation|, |spiritual or religious belief|).

|Staging and scales| represents assessment scales and tumor staging systems (e.g. |Glasgow Coma Scale|, |FIGO staging system of gynecological malignancy|).

|Qualifier value| represents the values for some SNOMED CT attributes, where those values are not subtypes of other top level concepts. (e.g. |left|, |abnormal result|, |severe|).

|Record artefact| represents content created for the purpose of providing other people with information about record events or states of affairs. (e.g. |patient held record|, |record entry|, |family history section|).

|SNOMED CT Model Component| contains technical metadata supporting the SNOMED CT release.

Concept model attributes – representing characteristics of a concept

SNOMED CT attributes (or relationship types) are used to represent a characteristic of the meaning of a concept. SNOMED CT currently uses more than fifty defining attributes when defining the meaning of concepts. Each SNOMED CT attribute can be applied to concepts in one or more branches of the hierarchy. The set of concepts to which an attribute can be applied is called the ‘domain’ of the attribute. The permitted set of values for each attribute is called the ‘range’ of the attribute.

Domain

The *domain* is the hierarchy to which a specific attribute can be applied.

For example:

The domain of the attribute |associated morphology| is the |clinical finding| hierarchy. Therefore, a |procedure| cannot have an |associated morphology|. However, a |procedure| can have a |procedure morphology|.

Range

The *range* is the set of SNOMED CT concepts that are allowed as the value of a specified attribute.

For example:

The range for the attribute |associated morphology| is the concept |morphologically abnormal structure| and its subtype descendants. The range for the attribute |finding site| is |anatomical or acquired body structure| and its subtype descendants in the |body structure| hierarchy.

Examples of the domain and range specified for the attributes |finding site| and |laterality|

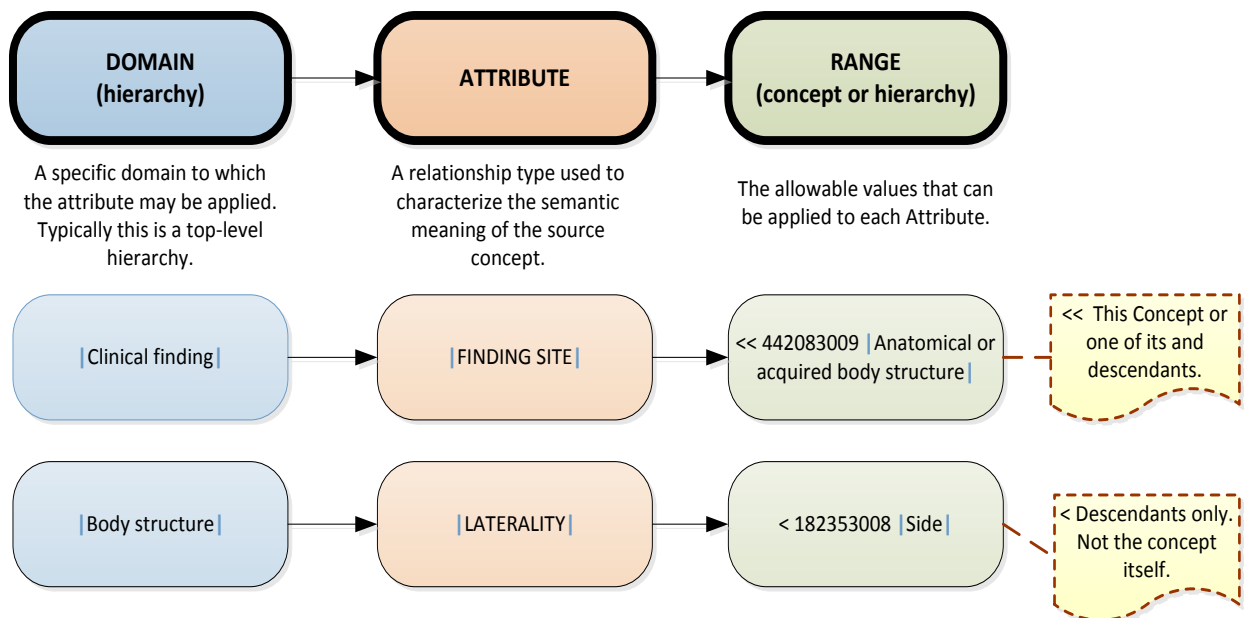

Some SNOMED CT attributes (or relationship types) have a hierarchical relationship to one another. The hierarchy formed from such relationships is known as an 'attribute hierarchy'. In an attribute hierarchy, one general attribute is the parent of one or more specific subtypes of that attribute. Subtypes of a concept defined using the more general attribute can be defined using a more specific subtype of that attribute. For example, |after|, |causative agent| and |due to| are subtypes of |associated with|, because they have a more specific meaning.

Attributes used to define SNOMED CT concepts

The SNOMED CT defining attributes are used to represent the meaning of concepts in these 9 hierarchies:

- ◆ Clinical finding concepts
- ◆ Procedure concepts
- ◆ Evaluation procedure concepts
- ◆ Specimen concepts
- ◆ Body structure concepts
- ◆ Pharmaceutical/biologic product concepts
- ◆ Situation with explicit context concepts
- ◆ Event concepts
- ◆ Physical object concepts

Attributes used to define clinical finding concepts

Below is a list of attributes used to define |clinical finding| concepts, and a brief description of their meaning:

|**Finding site**| specifies the body site affected by a condition

|**Associated morphology**| specifies the morphologic changes seen at the tissue or cellular level that are characteristic features of a disease.

|**Associated with**| represents a clinically relevant association between concepts without either asserting or excluding a causal or sequential relationship between the two.

|**After**| represents a sequence of events where a clinical finding occurs after another |clinical finding| or a |procedure|.

|**Due to**| relates a |clinical finding| directly to a cause such as another |clinical finding| or a |procedure|.

|**Causative agent**| identifies the direct causative agent of a disease such as an |organism|, |substance| or |physical force|. (Note: This attribute is not used for vectors, such as mosquitos transmitting malaria).

|**Severity**| used to sub-class a |clinical finding| concept according to its relative severity.

|**Clinical course**| represents both the onset and course of a disease.

|Episodicity| represents episodes of care provided by a physician or other care provider, such as a general practitioner. This attribute is not used to represent episodes of disease experienced by the patient.

|Interprets| refers to the entity being evaluated or interpreted, when an evaluation, interpretation or judgment is intrinsic to the meaning of a concept.

|Has interpretation|, when grouped with the attribute **|interprets|**, designates the judgment aspect being evaluated or interpreted for a concept (e.g. presence, absence etc.)

|Pathological process| provides information about the underlying pathological process for a disorder, but only when the results of that process are not structural and cannot be represented by the **|associated morphology|** attribute.

|Has definitional manifestation| links disorders to the manifestations (observations) that define them.

|Occurrence| refers to a specific period of life during which a condition first presents.

|Finding method| specifies the means by which a clinical finding was determined. This attribute is frequently used in conjunction with **|finding informer|**.

|Finding informer| specifies the person (by role) or other entity (e.g. a monitoring device) from which the clinical finding information was obtained. This attribute is frequently used in conjunction with **|finding method|**.

Attributes used to define procedure concepts

|Procedure site| describes the body site acted on or affected by a procedure.

|Procedure morphology| specifies the morphology or abnormal structure involved in a procedure.

|Method| represents the action being performed to accomplish the procedure. It does not include the surgical approach, equipment or physical forces.

|Procedure device| describes the devices associated with a procedure.

|Access| describes the route used to access the site of the procedure.

|Direct substance| describes the **|substance|** or **|pharmaceutical / biologic product|** on which the procedure's method directly acts.

|Priority| refers to the priority assigned to a procedure.

|Has focus| specifies the **|clinical finding|** or **|procedure|** which is the focus of a procedure.

|Has intent| specifies the intent of a procedure.

|Recipient category| specifies the type of individual or group upon which the action of the procedure is performed.

|Revision status| specifies whether a procedure is primary or a revision.

|Route of administration| represents the route by which a procedure introduces a given substance into the body.

|Surgical approach| specifies the directional, relational or spatial access to the site of a surgical procedure.

|Using substance| describes the substance used to execute the action of a procedure, but it is not the substance on which the procedure's method directly acts.

|Using energy| describes the energy used to execute an action.

Attributes used to define evaluation procedure concepts

|Has specimen| specifies the type of specimen on which a measurement or observation is performed.

|Component| refers to what is being observed or measured by a procedure.

|Time aspect| specifies temporal relationships for a measurement procedure.

|Property| specifies the kind of property being measured.

|Scale type| refers to the scale of the result of an observation of a diagnostic test.

|Measurement method| specifies the method by which a procedure is performed.

Attributes used to define specimen concepts

|Specimen procedure| identifies the procedure by which a specimen is obtained.

|Specimen source topography| specifies the body site from which a specimen is obtained.

|Specimen source morphology| specifies the morphologic abnormality from which a specimen is obtained.

|Specimen substance| specifies the type of substance of which a specimen is comprised.

|Specimen source identity| specifies the type of individual, group or physical location from which a specimen is collected.

Attributes used to define body structure concepts

|Laterality| provides information on whether a body structure is left, right, bilateral or unilateral. It is applied only to bilaterally symmetrical body structures which exist on opposite sides of the body.

Attributes used to define pharmaceutical/biologic product concepts

|Has active ingredient| indicates the active ingredient of a drug product, linking the **|pharmaceutical / biologic product|** hierarchy to the **|substance|** hierarchy.

|Has dose form| specifies the dose form of a product.



Attributes used to define situation with explicit context concepts

|Associated finding| Links concepts in the **|situation with explicit context|** hierarchy to their related **|clinical finding|**.

|Finding context| represents a situation in which a **|clinical finding|** is known, or unknown, and if known, whether it is present, absent or uncertain (possible), and to also express the meaning that the finding is not actual but is instead an anticipated or possible future finding.

|Associated procedure| links concepts in the **|situation with explicit context|** hierarchy to concepts in the **|procedure|** hierarchy for which there is additional specified context.

|Procedure context| indicates the degree of completion, or status of a **|procedure|**, as well as its various possible future states prior to its being initiated or completed.

|Temporal context| indicates the time of the occurrence of the situation, by indicating whether the associated procedure or finding is actual and therefore occurred in the present, in the past, or at a specified time; or that it is planned or expected in the future.

|Subject relationship context| specifies the subject of the **|clinical finding|** or **|procedure|** being recorded, in relation to the subject of the record.

Attributes used to define event concepts

|Associated with| represents a clinically relevant association between concepts without either asserting or excluding a causal or sequential relationship between the two.

|Occurrence| refers to the specific period of life during which a condition first presents.

Attributes used to define physical object concepts

|has active ingredient| indicates the active ingredient of a drug product, linking the **|pharmaceutical / biologic product|** hierarchy to the **|substance|** hierarchy.



7. SNOMED CT EXPRESSIONS

This section provides an overview of:

- ◆ Precoordinated Expressions
- ◆ Postcoordinated Expressions

Why is this important?

SNOMED CT provides a mechanism that enables clinical phrases to be represented, even when a single SNOMED CT concept does not capture the required level of detail. This is important as it enables a wide range of clinical meanings to be captured in a record, without requiring the terminology to include a separate concept for every detailed combination of ideas that may potentially need to be recorded. Application software that supports the use of SNOMED CT expressions enables detailed clinical information to be recorded, retrieved and analyzed.

What is this?

Clinical expressions using SNOMED CT concepts can be of two types: precoordinated expressions, which use a single SNOMED CT concept identifier; and postcoordinated expressions, which contain more than one SNOMED CT identifier.

SNOMED CT support of the postcoordination technique allows additional clinical detail to be represented if required. For example, |pneumococcal pneumonia| has a |finding site| of |lung structure|, which can be refined to |right upper lobe of lung|.

Postcoordination greatly increases the depth of detail that SNOMED CT can represent without having to include every possible specific site for every possible disorder via a concept. For example, the concept |bacterial pneumonia| has a defining relationship specifying its |causative agent| as |bacteria| and this can be refined to |Streptococcus pneumoniae|.

SNOMED CT expressions are a structured combination of one or more concept identifiers used to represent a clinical idea in a logical manner, which is automatically processable. Expressions are represented using the SNOMED CT compositional grammar, which is a lightweight syntax for the representation of SNOMED CT expressions.

The logic on which the SNOMED CT concept model is based allows alternative representations of the same or similar information to be recognized and compared. For example, |pneumococcal pneumonia| refined by |finding site| |right upper lobe of lung| can be computed to have the same meaning as |right upper lobe pneumonia| refined by |causative agent| |Streptococcus pneumoniae|.

Precoordinated expressions

Precoordinated expressions are expressions that represent the meaning of individual concepts which are predefined in SNOMED CT. Besides the unique concept identifier and descriptions, each concept also has a formal logic definition represented by a set of defining relationships to other concepts. The figure below shows the precoordinated expression used to record | fracture of tibia |. It illustrates that this can be represented by a single identifier, with or without an accompanying human-readable term. It also illustrates the defining relationships of the concept identified in the expression. This is the precoordinated definitional knowledge which is conveyed by this expression.

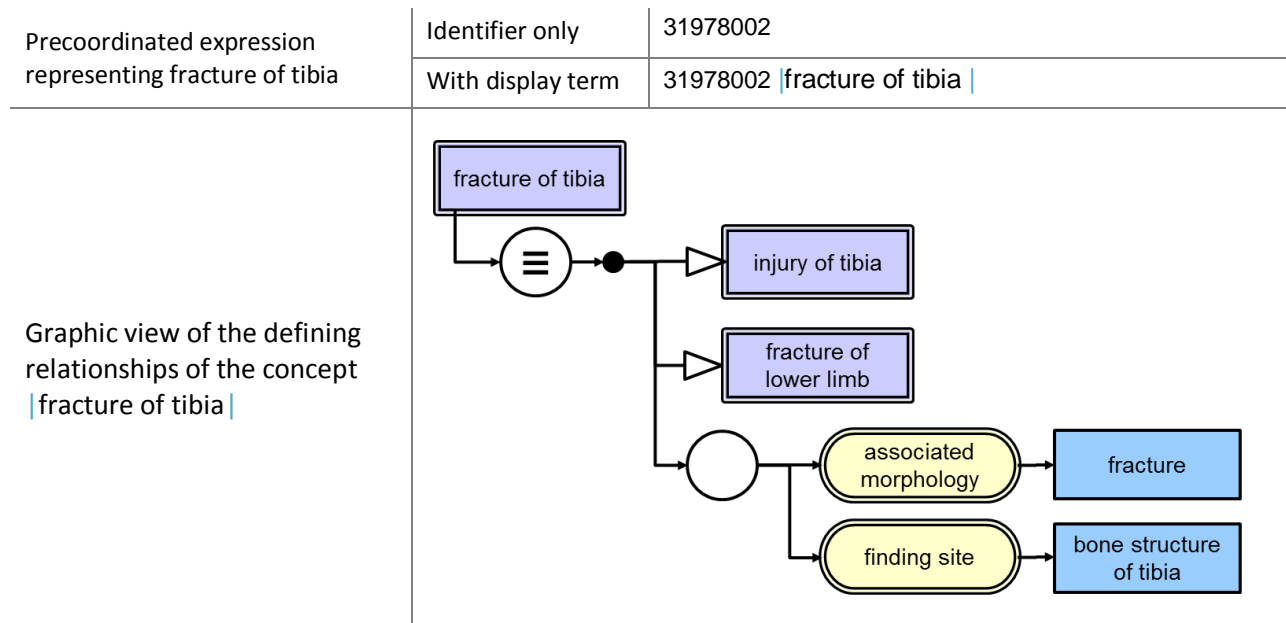

The second example shown below illustrates the fact that some SNOMED CT concepts provide quite a lot of detailed refinement, some of which might otherwise be captured separately. We will return to this example when considering postcoordination.

Example: Precoordinated representation of “Laparoscopic emergency appendectomy”

SNOMED CT contains the concept 174041007 |laparoscopic emergency appendectomy|. The identifier of this concept (174041007) can be used (with or without the associated term) as a precoordinated expression to record an instance of this procedure.

The procedure ‘laparoscopic emergency appendectomy’ has at least three distinct facets: ‘removal of appendix’, ‘using a laparoscope’ as ‘emergency procedure’. The SNOMED CT concept 174041007 |laparoscopic emergency appendectomy| precoordinates these facets as its definition includes the following defining relationships:

- ◆ 116680003 |is a| = 80146002 |appendectomy|
- ◆ 260870009 |priority|=25876001 |emergency|
- ◆ 425391005 |using access device| = 86174004 |laparoscope|

Postcoordinated expressions

Expressions that contain two or more concept identifiers are referred to as postcoordinated expressions. Postcoordination combines concepts and allows more detail to be added to the meaning represented by a single concept. A postcoordinated expression is not just a list of concept identifiers, it follows a set of rules that mimic the way attributes and values are used to define SNOMED CT concepts.

Example: Postcoordinated representation of “Laparoscopic emergency appendectomy”

Although SNOMED CT contains the concept |laparoscopic emergency appendectomy|, it is also possible to represent this clinical phrase using the following postcoordinated expression.

- ◆ 80146002|appendectomy|:260870009|priority|=25876001|emergency|, 425391005|using access device|=86174004|laparoscope|

This postcoordinated expression has exactly the same meaning as the precoordinated expression

- ◆ 174041007|laparoscopic emergency appendectomy|

The fact that the two expressions have the same meaning can be computed because

- ◆ 174041007|laparoscopic emergency appendectomy| is a fully-defined subtype descendant of 80146002|appendectomy| ; and
- ◆ the only differences between the defining attributes of these concepts are the addition of
 - 260870009|priority|=25876001|emergency|
 - 425391005|using access device|= 86174004|laparoscope|

The example above shows that postcoordination can be applied even when a single concept is available to represent the required means. However, the real strength of postcoordination is that it allows a clinical phrase to be represented even when the precise concept is not present in SNOMED CT. In these cases, postcoordinated refinements can be applied to an existing concept to more precisely capture the required meaning.

Example: Postcoordinated representation of “Laparoscopic removal of device from abdomen”

SNOMED CT does not contain a concept that represents this clinical idea. However, it is possible to represent it using the following postcoordinated expression.

68526006|removal of device from abdomen|:425391005|using access device|= 6174004|laparoscope|

Postcoordinated expressions may be created at run-time by selection of individual facets of a concept. For example, to indicate the nature and location of a fracture for a particular bone and, where relevant, whether the bone affected is on the right or left. Some applications allow generation of postcoordinated expression using natural language processing. Alternatively, postcoordinated expression can be selected during user interface design and bound to simple data entry options. In these cases, the user may not be aware that the information is being captured in a postcoordinated form.

Representing postcoordination

There are several valid ways to represent and store postcoordinated expressions. However, to support interoperability, IHTSDO has specified a standard SNOMED CT compositional grammar form that is both human-readable and computer processable. The examples of expression that you see in this guide use this grammar.

The basics of SNOMED CT compositional grammar

- ◆ At its simplest level a single SNOMED CT concept identifier is a valid expression.
 - 80146002
- ◆ A concept identifier can optionally be followed by a term associated with that concept enclosed between two pipe characters
 - 80146002|appendectomy|
- ◆ A concept identifier (with or without a following term) can be followed by a refinement. The refinement follows a colon
 - 80146002|appendectomy|:<refinement>
- ◆ A refinement consists of a sequence of one or more attribute-value pairs. Both the attribute and the value are represented by a concept identifier (with or without a following term). The attribute is separated from the value by an equals sign
 - 80146002|appendectomy|:260870009|priority|=25876001|emergency|
- ◆ If there is more than one attribute-value pair, the pairs are separated by commas
 - 80146002|appendectomy|:260870009|priority|=25876001|emergency|,425391005|using access device|=86174004|laparoscope|
- ◆ Curly braces represent grouping of attributes within a refinement, for example to indicate that the method applies to a specific site
 - 80146002|appendectomy|:{260686004|method|=129304002|excision - action|,405813007|procedure site - direct|=181255000|entire appendix|}
- ◆ Round brackets represent nesting to allow the value of an attribute to be refined
 - 161615003|history of surgery|:363589002|associated procedure|= (80146002|appendectomy|:260870009|priority|=25876001|emergency)

Postcoordination and the concept model

The refinements used in postcoordinated expressions should follow the same concept model rules that are applied when concepts are defined. Attributes should only be applied to concepts that are in the specified 'domain' for that attribute. The values applied to attributes should be limited to the specified 'range' for that attribute. These rules may sometimes seem to limit flexibility but these rules are important, because if they are followed, it is possible to compute similarities and subtype relationships between different expressions. This ability to compute subtypes is the key to effective meaning-based retrieval of postcoordinated expressions.

Example: Postcoordination and concept model rules

A disease with a particular morphological abnormality at a particular site is represented in the following way:

- ◆ 64572001 |disease| : { 363698007 |finding site|= 91723000 |anatomical structure| , 116676008 |associated morphology|= 49755003 |morphologically abnormal structure| }

It must **not** be represented in other ways that conflict with concept model rules such as:

- ◆ 49755003 |morphologically abnormal structure| : 363698007 |finding site|= 91723000 |anatomical structure|
- ◆ 64572001 |disease| : 363698007 |finding site|= (91723000 |anatomical structure| : 116676008 |associated morphology|= 49755003 |morphologically abnormal structure|)
- ◆ 64572001 |disease| : 116676008 |associated morphology|= (49755003 |morphologically abnormal structure| : 363698007 |finding site|= 91723000 |anatomical structure|)

In some cases, postcoordination may be simply a matter of choosing one of the subtypes of a defining attribute value. For example the definition of |total hip replacement| includes the attribute |direct device| with the value |total hip replacement prosthesis|. The subtypes of this value include different types of prosthesis, some of which are shown in the graphical view of the concept definition below. One of these more specific values can be selected to specify the type of prosthesis actually used.

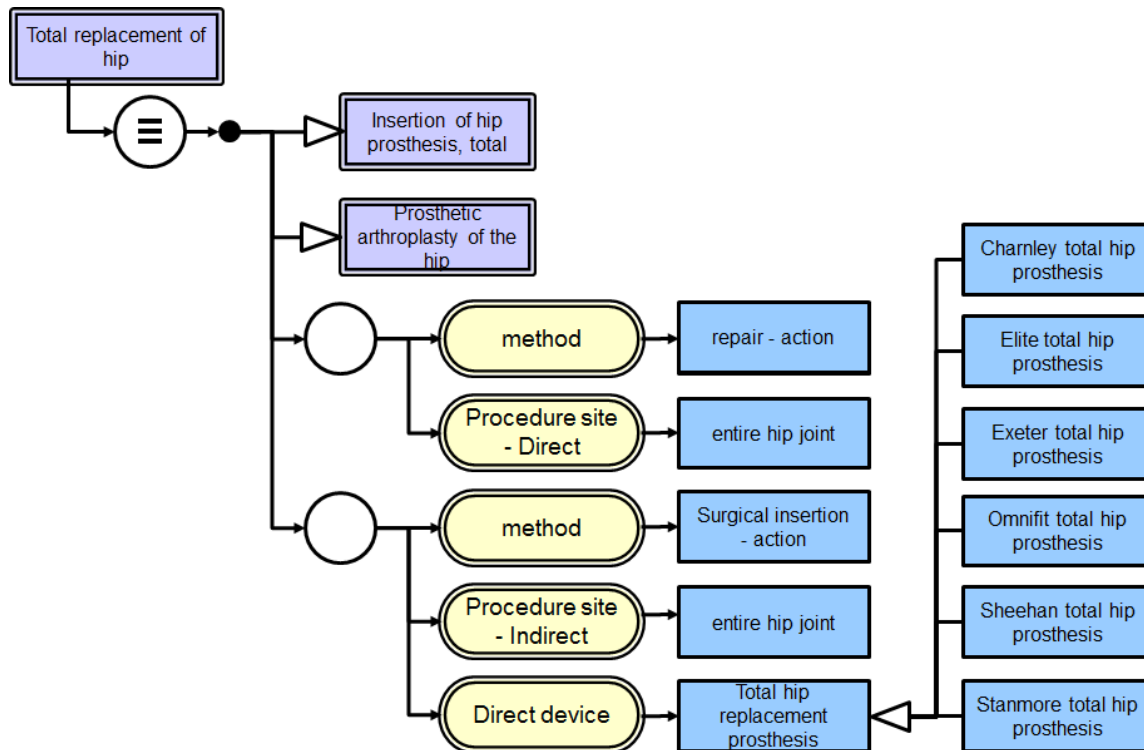

In the same way clinical situations, such as family history, can be recorded for any disorder and are not limited to a predefined set of conditions.

Example: Postcoordination of family history

The definition includes 246090004 | associated finding | =246090004 | disease | . This value can be refined to refer to a particular disease. For example:

- ◆ 281666001 | family history of disorder | :246090004 | associated finding | =22298006 | myocardial infarction |

The definition of | family history of disorder | specifies that the | subject relationship context | is | person in family of subject | . This value indicates that the finding applies to a family member rather than the patient and can be refined to refer to a particular family member. For example:

- ◆ 281666001 | family history of disorder | : { 246090004 | associated finding | =22298006 | myocardial infarction | , 408732007 | subject relationship context | =444295003 | father of subject | }

Consistent retrieval of precoordinated and postcoordinated expressions

SNOMED CT expressions support consistent and comparable representation of meaning using both precoordinated and postcoordinated expressions. This facilitates retrieval of all instances of expressions that match a set of criteria specified using the subtype hierarchy and other defining relationships.

Example: Laparoscopic procedures

Several earlier examples in this chapter have represented procedures. If there was a requirement to retrieve all laparoscopic procedures the first step would be to establish the criteria for inclusion. The requirement could be expressed as follows.

- ◆ 51316009 | laparoscopic procedure | and all its subtypes

In some cases, it is simply a question of looking at the subtype hierarchy.

For example

- ◆ 174041007 | laparoscopic emergency appendectomy | is the source of a sequence of | is a | relationships which lead to 51316009 | laparoscopic procedure | .

In other cases, it is necessary to look at the definition of | laparoscopic procedure | and compare this with the equivalent expression. | Laparoscopic procedure | is fully-defined as follows.

- ◆ 71388002 | procedure | : 425391005 | using access device | = 86174004 | laparoscope |

Therefore, queries looking for instances of laparoscopic procedures should also retrieve postcoordinated expressions in which both of the following are true:

- ◆ The focus concept is a subtype of 71388002 | procedure |
- ◆ The attribute 425391005 | using access device | is present with the value 86174004 | laparoscope | or a subtype of that concept.

This rule would include postcoordinated representations, such as the following expression, for which there is no existing SNOMED CT concept:

- ◆ 68526006 | removal of device from abdomen | : 425391005 | using access device | = 6174004 | laparoscope |

The following graphics illustrate the ways in which query predicates based on SNOMED CT concept definitions can be used to retrieve data based on different criteria. In each case, the data retrieved includes expressions that either have attributes matching the criteria or refer to a concept with defining relationships that match the query criteria.

Example: Result of retrieving concepts with /associated morphology/ specified as /benign neoplasm/

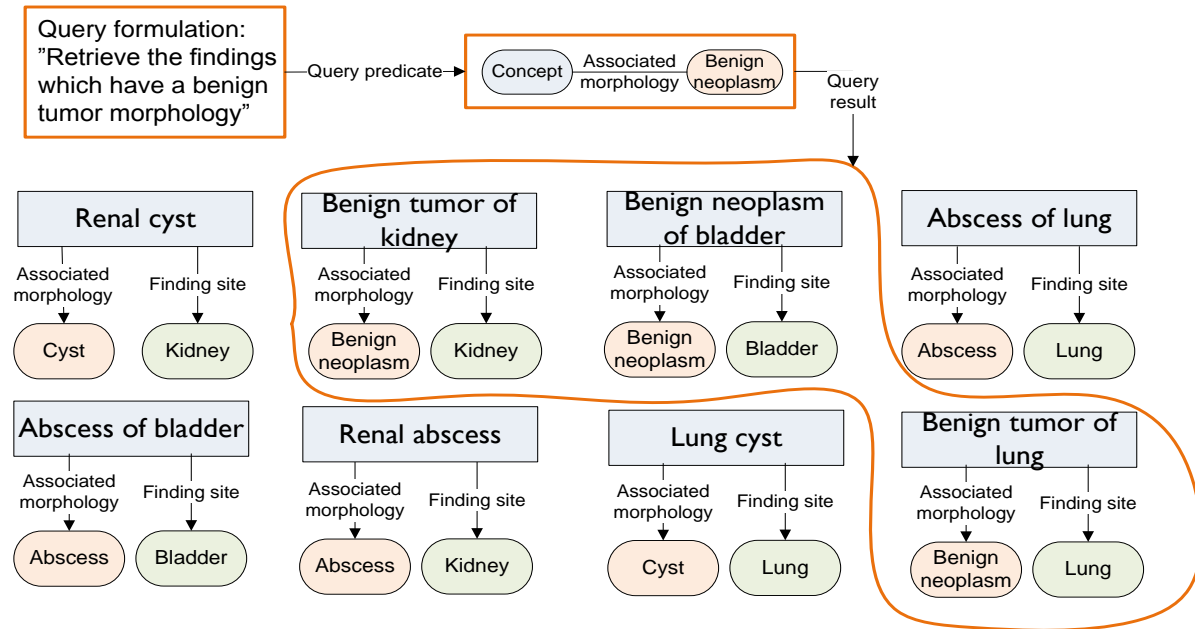

Example: Result of retrieving concepts with /finding site/ specified as /kidney/

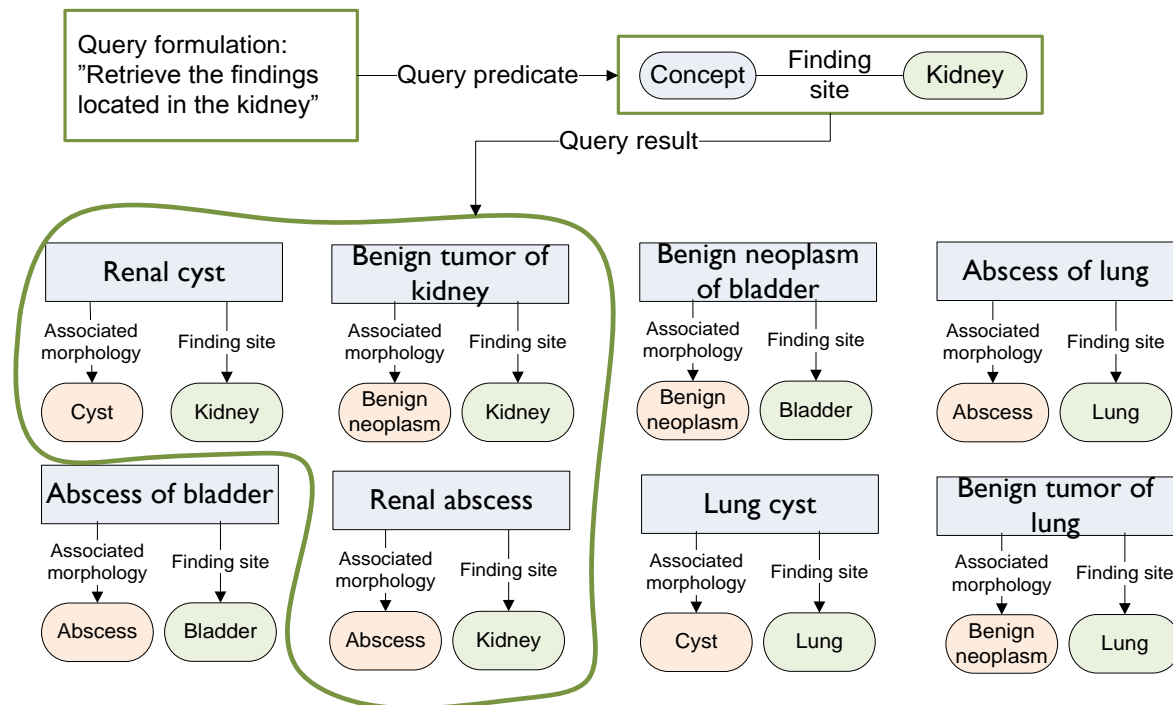

8. SNOMED CT IMPLEMENTATION

This section provides an overview of:

- ◆ How is SNOMED CT used?
- ◆ Implementation Examples
 - Clinical Record Applications
 - Clinical Decision Support
 - Enabling Interoperability
 - Reporting
- ◆ SNOMED CT in action

Why is this important?

Realization of the benefits described in Chapter 2 - SNOMED CT Benefits, depends on using the terminology in software applications. The extent of benefits realization depends on the effectiveness of implementation and the way SNOMED CT is used within the system and by users and organizations.

What is this?

How is SNOMED CT used?

SNOMED CT itself is only a part of the solution to addressing the requirements for effective electronic clinical records. A terminology on its own 'does nothing'. To benefit from a terminology, it must be implemented and used as part of an application. The design of the software application in which it is used, and the objectives and motivation of its users, are key factors in determining success.

SNOMED CT is useful for clinical documentation, as it supports the representation of detailed clinical information, in a way that can be processed automatically. Realization of the capability of SNOMED CT to support clinical information and meaning based retrieval requires careful consideration of the actual setting, in terms of scope of use, record structure, data entry, data retrieval and communication.

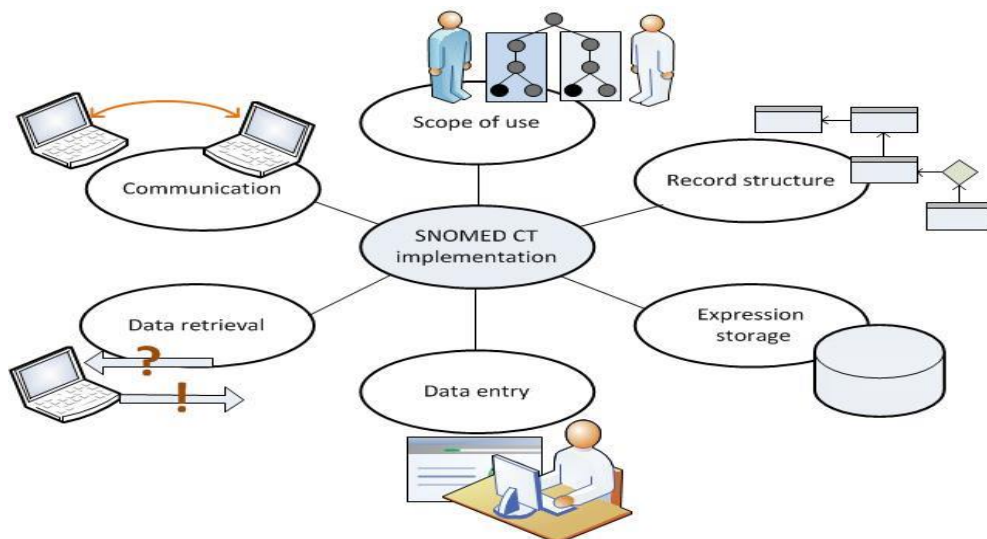



Implementation Examples

Clinical record applications

SNOMED CT can be implemented in a wide range of clinical record applications. These include systems developed for use with other code systems that have been adapted to support SNOMED CT as well as systems designed with the assumption that SNOMED CT would serve as the primary terminology. The SNOMED CT features that applications support and use may vary, partly due to differences in user requirements and partly due to development priorities.

A terminological resource is only one part of a software application. The functions required to implement a terminology can be divided into:

- ◆ Terminology services: Functions that can be performed without reference to data stored in a particular application record structure.
- ◆ Record services: Functions that involve storing, retrieving or processing application data (e.g. patient health records).

Different applications may make use of different aspects of SNOMED CT. Applications that only require SNOMED CT for a very limited range of uses and may not require all the features of SNOMED CT. However, by using SNOMED CT, these applications benefit from an enhanced ability to exchange data with other more terminology rich applications. These applications can also evolve to meet emergent requirements by making increasing use of the power of SNOMED CT.

Most users only require a small subset of the content of SNOMED CT. However, use of a terminology that spans a wide range of specialties delivers the benefits that arise from consistency, and interoperability.

Clinical decision support

How can the use of SNOMED CT assist in clinical decision support?

Clinical decision support is defined broadly as a clinical system application or process that helps health professionals make clinical decisions to enhance patient care. An example of clinical decision support would be the use of alerts to identify specific clinical contraindications in the administration of thrombocytopenia therapy after a stroke.

The use of SNOMED CT makes clinical information available in a computable form which can be queried and used to trigger decision support rules and prompts. The hierarchies of SNOMED CT enable complex reasoning to support decision support rules. For example, in SNOMED CT the concept |stroke| is synonymous with |cerebrovascular accident| and subsumes all lower level concepts including |paralytic stroke|, |thrombotic stroke| etc. This means that decision support queries are easier to develop and implement because they do not need to identify all the individual terms and codes which may be relevant.

Has it been implemented?

Yes. SNOMED CT is known to be used for Clinical Decision Support in a number of organizations including Kaiser Permanente, Duke University Medical Hospital in the US; National Health Service Hospitals in the UK and Hospital Italiano in Buenos Aires, Argentina.

Kaiser Permanente has a central terminology service which develops and maintains clinical decision support rules and prompts. These can be quickly distributed for implementation throughout the

Organisation. In addition to using this type of approach for clinical decision support, Kaiser Permanente also use it to identify potential cohorts for clinical trials etc.

Enabling interoperability

How can you ensure that clinical information entered in one context can be safely and accurately transmitted to another system in another context?

Information can be recorded using SNOMED CT concepts and descriptions that are independent of the clinical information system being used and either independent of or tied to the context of use, depending on the user requirements. SNOMED CT is a common clinical terminology covering a wide range of requirements and its use. SNOMED CT allows meaning-based computation to be applied to information in messages sent between systems, and provides a foundation for interoperable interpretation of clinical information.

For example, subtype descendant concepts that may be relevant to prescribing decisions (e.g. |allergy to substance |, |kidney disease |) can be used to trigger alerts and reminders in the recipient system, such as medication allergy alerts and drug level investigation warnings. These preventative health care reminders, enable the quality of care to be improved.

Has it been implemented?

Yes. In the United States, Kaiser Permanente (KP), The Veterans Health Administration (VHA), and the Department of Defense (DoD) health systems currently interoperate using SNOMED CT. A consortium comprised of Kaiser Permanente, the Mayo Clinic, Intermountain Health Care, Geisinger Health System, and Group Health Cooperative of Puget Sound has announced they will interoperate using SNOMED CT and techniques established by KP, the VHA and DoD.

Reporting

How can clinical information encoded as SNOMED CT concepts be used for reporting purposes?

Information encoded as SNOMED CT concepts is semantically consistent. In other words, there is one unique SNOMED CT identifier representing each separate meaning. This lends itself to reporting through specifying the SNOMED CT identifiers of interest. SNOMED CT supports recording at appropriate levels of detail and using relevant terms. This also means that reports can be generated at the appropriate levels of detail using relevant terms for display in the report.

The hierarchical nature of SNOMED CT means that information can be aggregated at the appropriate levels of generalization. That same information can also be used in reporting to provide the same level of detail. SNOMED CT is a common clinical terminology covering a wide range of requirements and supporting a wide variety of use cases for reporting, including patient care, clinical audit, quality improvement, outcomes, epidemiology, patient safety, etc. As SNOMED CT is a clinical terminology with a global scope, reports using SNOMED CT can be compared across boundaries.

Where required, SNOMED CT may also be mapped to other code systems and classifications to support existing reporting requirements.



Has it been implemented?

Yes, many clinical information systems use SNOMED CT to varying degrees and many standards mandate or recommend that SNOMED CT be used. Such cases include reports sent using HL7 messages, microbiology results reporting, and genetic database reports.

Other examples of SNOMED CT in action

You can see other examples of implementations using SNOMED CT in a dynamically maintained list at www.snomedinaction.org. This site also allows you to add summaries of implementations that you are involved in.





9. CONTENT DEVELOPMENT

This section provides an overview of:

- ◆ SNOMED CT International Release Content Development
- ◆ Request Submission

Why is this important?

Understanding the quality and rigor of the approach to SNOMED CT content development ensures user confidence in the quality of the content when implementing or using SNOMED CT.

What is this?

SNOMED CT international release content development

SNOMED CT's content development is based on four basic principles that have and continue to guide development of its clinical content and technical design including:

- ◆ Development efforts must encompass broad, inclusive involvement of diverse clinical groups and medical informatics experts.
- ◆ The clinical content must be quality focused and adhere to strict editorial rules.
- ◆ The quality improvement process must be open to public scrutiny and vendor input, to ensure that the terminology is truly useful within health care applications.
- ◆ There must be minimal barriers to adoption and use.

The content of SNOMED CT evolves with each release. The types of changes made include new concepts, new descriptions, new relationships between concepts, and new reference sets, as well as updates and retirement of any of these components. Drivers of these changes include changes in understanding of health and disease processes; introduction of new drugs, investigations, therapies and procedures; and new threats to health, as well as proposals and work provided by SNOMED CT users.

The three basic operational criteria that help determine whether new content is following the principle of creating and sustaining semantic interoperability are that SNOMED CT must be:

- ◆ Understandable: The meaning must be able to be communicated, to be understood by an average health care provider without reference to inaccessible, hidden or private meanings.
- ◆ Reproducible: It is not enough for one individual to say they think they understand the meaning. It must be shown that multiple people understand the meaning in the same way.
- ◆ Useful: The meaning must have some demonstrable use or applicability to health or health care.

Recognizing the goal that SNOMED CT should become the accepted international terminological resource for health care, it must therefore be capable of supporting multilingual terminological renderings of common concepts. For the terminology to be acceptable to the widest possible range of users it must include translations as well as alternative spellings and other variations that arise from a national and regional dialect. Furthermore it must be capable of representing differences between the underlying concepts that arise from cultural, ethnic or linguistic variations.



Clinical terminology development is challenging for a variety of reasons. Even in a single country or language people often use the same words to mean different things, as well as using different words for the same thing. The names assigned to some clinical conditions are sometimes based on an earlier incomplete or erroneous understanding and often these misleading names remain in use long after knowledge has moved on. Progress of medical knowledge and evolution of pathogenic organisms creates a continual, growing requirement to add new content and revise definitions. Efforts by specialty bodies to establish diagnostic criteria and staging scales also lead to changes, and sometimes to divergence between different or overlapping sources of authority. In the face of these challenges, content development is directed to address current and emerging priorities identified by IHTSDO Members and other stakeholders.

Continuous quality improvement is the aim of IHTSDO. Quality processes are included as part of the work completed by the team of modeler's involved in SNOMED CT development. A documented scientific process is followed and content is defined and reviewed by multiple clinician editors. Conflicts between editors are resolved through an iterative process, based on achieving agreement and consensus, before being entered into the terminology. As necessary, the authoring team consult with additional experts to review the scientific integrity of the content.

Requesting content additions and changes

IHTSDO provides a request submission service to gather and process requests for additions and changes to the content of the SNOMED CT International Edition. This service is directly accessible by National Release Centers (NRC) in Member countries and recognized Terminology Authorities within organizations with whom IHTSDO is actively collaborating. Organizations within Member countries can submit their requests for additions and changes to the National Release Centre. In some cases, requests with particular local relevance may be added to a National Extension. The NRC forwards requests that it considers have international relevance to the IHTSDO for a decision. If a request is deemed to have high priority it should result in action in the next release cycle. However, requests that require significant changes that would impact on other content may take longer.

10. EXTENSION AND CUSTOMIZATION

This section provides an overview of:

- ◆ Extension Content
- ◆ Reference Sets

Why is this important?

SNOMED CT is designed to allow the International Edition to be enhanced by adding Extensions that address national or local requirements. Additional content required to support national, local or organizational needs that may not have international relevance or may not meet the editorial guideline for inclusion in the International Edition.

SNOMED CT design also includes the Reference Set mechanism which provides a standard way to customize and enhance content for use in a particular country, language, specialty, application or context. Reference Sets developed nationally or locally can modify search and display of content from the International Edition as well as enhancing Extension content.

What is this?

Extension content

Many clinical concepts are relevant in all countries, organizations and specialties but some concepts are relevant only to a particular environment. SNOMED CT is designed to allow the International Edition to be enhanced by adding Extensions to meet national or local requirements without compromising the main body of SNOMED CT. This is intended to meet the needs of different specialties and countries, regions, vendors and healthcare institutions.

Extensions are managed by IHTSDO Members or Affiliates who have been issued with a Namespace Identifier. A Namespace Identifier distinguishes the Identifiers of the Components created by an Organisation. The responsibilities of organizations that create an Extension and provide it for use by other organizations include:

- ◆ Maintaining Concept, Descriptions, Relationships, and Reference Sets that they create.
- ◆ Inactivating these components as appropriate (duplication, ambiguous, outdated, etc.)

The Concepts, Descriptions, Relationship and Reference Sets that form an Extension use a namespace identifier, which ensures that their SNOMED CT identifier is different from components in:

- ◆ SNOMED CT International Release,
- ◆ Other SNOMED CT Extensions

The namespace identifier is part of the component identifier. Therefore, components are distinguishable not only in the thesaurus, but also when stored in a patient record, query or decision support protocol.

Extensions use the same file structure as the core International Release. This ensures that:

- ◆ SNOMED CT enabled implementations can benefit from the content in these Extensions without the need for any additional software development;
- ◆ The same application software can be used to enter, store and process information from different extensions;
- ◆ Reference Sets can be constructed that refer to content from the International Release and a variety of Extensions.

Software applications should allow the users or user communities to specify the Extensions to be recognized by their systems.

An Extension should only be recognized if:

- ◆ It has been supplied by the IHTSDO or another Organisation authorized by the IHTSDO to provide such Extensions;
- ◆ The recognizing Organisation is satisfied with the quality control procedures of the providing Organisation.

The fact that an Organisation is permitted to produce Extensions does not imply any seal of approval related to the quality of Extensions provided by that Organisation. Therefore a person or Organisation that recognizes or installs an Extension does so entirely at their own risk.

Reference sets

SNOMED CT has a broad clinical coverage and includes a depth of detail appropriate to a range of health care disciplines and clinical specialties. As a result, it has extensive content, different parts of which are needed in particular environments. The SNOMED CT design includes the Reference Set mechanism, which provides a standard way to refer to a set of SNOMED CT components and to add customized information to a component.

Organizations implementing SNOMED CT benefit from Reference Sets because they allow requirements for use of particular descriptions and concepts to be represented in a standard form that can be applied to any SNOMED CT enabled application. This allows Reference Sets to be shared throughout and between organizations, even when different software is used to meet local or departmental requirements.

Software developers and vendors benefit because Reference Sets provide a common, machine processable representation of requirements for different patterns of use of SNOMED CT. This simplifies local configuration and enhances interoperability with other SNOMED CT enabled applications.

Reference sets can be used for many different purposes, including:

- ◆ **Language and dialects** are represented as Language Reference Sets (see Chapter 11 - Translations and Language Preferences).
- ◆ **Maps to and from other code systems and classifications** are represented as Simple, Complex or Extended Map Reference Sets (see Chapter 12 - Mapping).

- ◆ **Subsets of concepts, description or relationships** are represented as Simple Reference Sets. The only information that a Simple Reference Set provides is that a component is part of this subset. Subsets may be used for a variety of general and specific purposes, some of which are identified in the following examples.
- ◆ **Ordered lists and navigation hierarchies** are represented as Ordered Reference Sets. These offer additional functionality to meet advanced variants of the requirements addressed by component subsets.

General use cases for subsets represented as Simple Reference Sets

- ◆ **Excluding content**
 - For example, the “Non-human Reference Set” excludes content which is only relevant in veterinary medicine.
- ◆ **Including content**
 - Limiting searches to content of specific interest to a specialty or specific data entry context
 - In some cases very limited subsets can be presented as dropdown lists or option boxes rather than searches.
- ◆ **Prioritizing content**
 - In some cases, a subset represents an initial priority list of options but the full content of SNOMED CT is searchable when required.
 - Note that Ordered Reference Sets support more flexible prioritization.
- ◆ **Managing use of codes in messages and communications**
 - A Simple Reference Set may represent a value set applicable to a particular field in a message.

Specific use cases for subsets represented as Simple Reference Sets

- ◆ **National, jurisdictional or organizational requirements**
 - Collecting particular minimum sets of data using specific codes.
- ◆ **Regional variations in disease prevalence**
 - Providing prioritized access to diseases that are prevalent in the region where data is being collected.
- ◆ **Specialty and discipline variations**
 - The frequency of use of particular concepts depends on the professional discipline and/or clinical specialty of the user. Specialty subsets can optimize data entry.
- ◆ **Supporting data entry protocols**
 - Different subsets of concepts are relevant at different points in different data entry protocols. Subsets represented as Simple Reference Sets can be used to restrict the available options to match the requirements at particular points in a data entry protocol.



Reference set development

Generic data structures for Reference Sets have been used to create a simple core structure that can be extended to meet a variety of requirements. This has been done rather than developing a complex and inextensible structure that can only be used in a finite and constrained number of ways to enforce editorial policy.

Creating a new Reference Set requires access to a namespace in order to generate SNOMED CT Ids. Within that namespace, at least one module ID concept (with an FSN and Preferred Term) should be added under the |module| sub-hierarchy (within the Core Metadata) for each of the authoring organizations. The steps required to create a new reference set include:

1. Create the Reference Set Concept in the Foundation Metadata hierarchy.
2. Define the Reference Set Attributes within the metadata hierarchy.
3. Create the Descriptor for the Reference Set (by adding members to the Reference Set Descriptor Reference Set).
4. Add members to the Reference Set.

Please note that step 2 does not need to be performed if using one of the standard Reference Set types that have been predefined in the international release of SNOMED CT. The Reference Set Attributes for these predefined Reference Set types have already been added to the international release.

It is recommended that for each reference set, there is formal documentation that records (at a minimum) the rules, principles and approach used to determine the members of that reference set.

Reference Sets need to be maintained and the content re-examined when new releases of SNOMED CT are made available. Processes need to be established to address the concepts that have become inactive and the new concepts added in each new release.

11. TRANSLATIONS AND LANGUAGE PREFERENCES

This section provides an overview of:

- ◆ Requirements for translations and language preferences
- ◆ Translation approaches
- ◆ How SNOMED CT represents translations

Why is this important?

The basic objective of any SNOMED CT translation is to provide accurate and unambiguous descriptions of SNOMED CT concepts in the target language.

What is this?

SNOMED CT is a multinational, multilingual terminology. It has a built-in framework to manage different languages and dialects. Today, SNOMED CT is available in several languages, including US English, UK English, Spanish, Danish and Swedish, and more translations are continuously being done by member countries.

The goal of any SNOMED CT translation is to provide accurate representations of SNOMED CT concepts in a way that is understandable, usable, and safe. Translations must be concept-based, as term-to-term translations may yield literal expressions that are often meaningless. Instead, the translator analyses each concept based on the position within the hierarchy, the descriptions, and relationships to other concepts before deciding on the most meaningful translation of a concept. IHTSDO provides guidelines to support countries undertaking translations.

Translation approaches

SNOMED CT translation is an interdisciplinary collaboration which requires careful attention to content, structure and clinical relevance. These factors are of foremost importance in order to ensure the usability of the terminology in connection with implementation in electronic health record systems. Both linguistic and semantic quality must be assured.

The core SNOMED CT is not perfect and its structure and content continue to evolve. These facts call for vigilance on the part of the translation team members who need to review and analyse the relationships of each concept in order to elucidate the meaning of a term within the terminological context. Looking at the preferred term in English is not sufficient to enable accurate concept-based translation.

Close collaboration between specialists in health informatics, linguistics and terminology is essential for the translation process. A translation based solely on linguistic, morphological-syntactical analysis might result in a seemingly correct term which may not adequately represent the concept in question, nor be used by healthcare professionals. On the other hand, compliance with linguistic, systematic, and orthographic principles is necessary in order to avoid confusion and ensure the practical applicability of the terminology.



It is crucial that those involved in the translation, verification, validation, and approval processes are familiar with the terminological principles on which SNOMED CT is based. It is equally important that they comply with IHTSDO Style Guides and that they are conscious of issues such as the choice of lexical variant, term requirements, translation techniques, and the importance of ensuring linguistic consistency.

Additionally, it is important that those involved in the translation process are aware that sometimes, their inability to understand a given term or concept may be caused not by their own lack of insight, but actually by a mistake or an ambiguity in the core terminology (international release) that needs to be corrected. SNOMED CT undergoes constant improvement, mistakes are corrected, and ambiguities are addressed. To ensure this constant enhancement of SNOMED CT, any translation team should register questions, comments or suggestions and forward these to the IHTSDO in order to avoid spending extra time on unsolvable issues and at the same time contribute to discovering any mistakes and ambiguities. Currently, questions and remarks from the translation teams are dealt with by the IHTSDO request submission process.

How SNOMED CT represents translations

From a practical perspective, the deliverables from SNOMED CT translation include:

- ◆ **Descriptions** – each of which contains a term in the target language which accurately reflects the meaning of the concept with which it is associated.
- ◆ **A Language Reference Set** – containing references to each of the descriptions and an indication of whether it is preferred or acceptable for use in the particular language or dialect.

This approach allows the same descriptions to be used in other local variants of the language. In this case another Language Reference Set is provided indicating which descriptions contain the preferred and acceptable terms. Descriptions not referenced by a Language Reference Set are not used in that language or dialect.

12. MAPPING

This section provides an overview of:

- ◆ Mapping approaches
- ◆ How SNOMED CT represents maps
- ◆ Steps in a mapping process

Why is this important?

Clinical information recorded using SNOMED CT may include data that is relevant to reports, statistical returns, billing claims, etc. that need to be encoded using a specific code system or a statistical classification such as ICD-10. Mapping allows relevant information to be used for those purposes, minimizing the requirement for additional manual data entry.

Organizations planning to implement SNOMED CT based solutions may also be faced with data transformation and migration challenges which lead them to consider mapping their existing clinical data, code systems or classifications to SNOMED CT.

As a common global reference terminology, SNOMED CT limits the need for development of “everything to everything” maps between multiple different code systems.

Problem: Map Everything to Everything

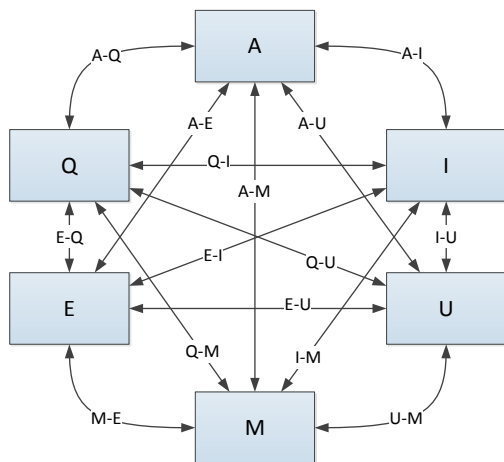

Solution: Map to a SNOMED Clinical Terms

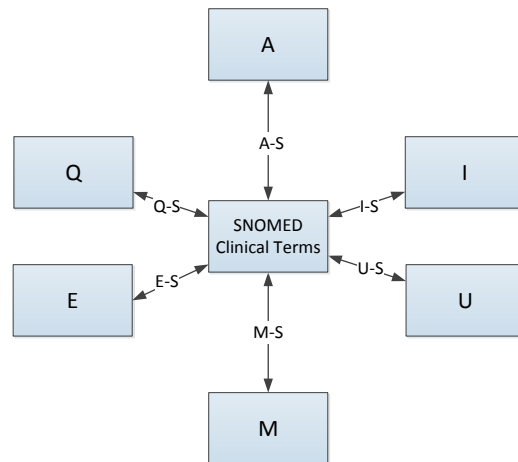

What is this?

Maps are associations between particular codes, concepts or terms in one code system and codes, concepts or terms in another code system that have the same (or similar) meanings. Mapping is the process of defining a set of maps. Maps are developed in accordance with a documented rationale, for a given purpose and as a result there may be different maps between the same pair of code systems to meet different uses cases.

There are a number of different types of mapping activities that an Organisation may need to undertake. These include mapping:

- ◆ SNOMED CT to a statistical classification (such as ICD-10)
- ◆ Classifications to SNOMED CT
- ◆ Other standard code systems to or from SNOMED CT
- ◆ Locally developed code systems to SNOMED CT
- ◆ Locally collected clinical data documented as free text to SNOMED CT

The completeness of mapping between two code systems depends on the scope, level of detail provided by the two schemes and the precision of mapping required to safely meet the intended mapping use case.

Mapping approaches

The approaches used when undertaking mapping include human mapping, automatic mapping or a combination of both of these.

Automatic mapping is when computer algorithms are used to create maps between concepts and or terms - for example between local clinical content and SNOMED CT. Lexical mapping, where the structure of the words in the clinical term is compared and analyzed as to whether the words are the same, similar or different, is often incorporated within automatic mapping. Significant care must be taken with automatic mapping, because severe mapping errors can result if not done in a controlled way. Automatic mapping, in conjunction with human review (and manual remapping where necessary), is likely to achieve better results than automatic mapping alone.

Human mapping is the use of human knowledge and skill to author maps. Each map is built singly and individually. The process requires examination of each and every concept in the coding system. Informed judgments or decisions are made about the shared meaning of concepts. Electronic or computational tools are used, but only in support of work process.

How SNOMED CT represent maps

SNOMED CT specifications and content include resources that support mapping to and from other code systems, classifications and terminologies. These resources support simple, complex and extended mappings. Simple maps, where there is a one-to-one Relationship between a SNOMED CT concept and code in a target scheme, are represented using a Simple Map Reference Set. Complex and Extended Map Reference Sets enable the representation of:

- ◆ Maps from a single SNOMED CT concept to a combination of codes (rather than a single code) in the target scheme.
- ◆ Maps from a single SNOMED CT concept to choice of codes in the target scheme. In this case, the resolution of the choices may involve:
 - Manual selection supported by advisory notes.
 - Automated selection based on rules that test other relevant characteristics in the source data (e.g. age and sex of the subject, presence or absence of co-existing conditions, etc.).
 - A combination of automated processing with manual confirmation or selection where rules are insufficient to make the necessary decisions.

Steps in a mapping process

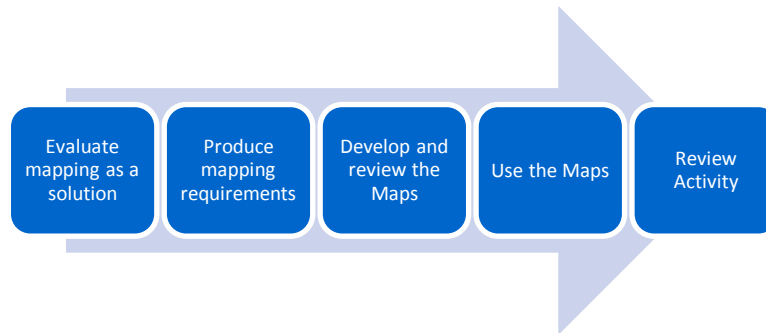

The main steps to be completed and documented when completing a mapping process include:

- ◆ Evaluate mapping as a solution
- ◆ Produce mapping requirements
- ◆ Develop and review the maps
- ◆ Use the maps
- ◆ Review activity

Evaluating mapping as a solution

When approaching the creation of a map, the first step is to understand the data which needs to be transformed or migrated and the requirements for use of that data. Key questions to address include:

- ◆ Are the business requirements well understood?
- ◆ Are there other options for meeting the business requirements without mapping?
- ◆ To what extent can the source data contribute value to the target data?
- ◆ What are the options?
- ◆ What requirements are there beyond developing and delivering the maps? (e.g. enabling appropriate use of the maps for data conversion).
- ◆ What is the scope of the mapping exercise?
- ◆ What are the expert resource requirements and costs of creating, quality assuring and maintaining the maps?
- ◆ What are the potential risks arising from using the maps?

Produce mapping requirements

It is essential to fully understand the structure, content and semantics of both the source and target code systems. It is also important to understand how the meaning of the codes is affected by the structure and functionality of the source and target systems. Once the code system and how it has been used is fully understood, a document should be created which defines the rules to be applied when creating maps to or from SNOMED CT. These rules will address for example, the approach to inexact mappings, the use of synonyms, postcoordinated expressions and others. In order to be able to understand the evolution of the maps, an audit trail of the map creation and maintenance activity should be maintained.



Human resource requirements are dependent on the mapping scale, the model used for mapping and the type and complexity of the map being developed. The roles that may be required could include mapping sponsor, mapping manager, mapping specialist, clinical specialists and a mapping advisory group.

Once all requirements have been defined, appropriate software tools to support the creation of the maps must be decided upon. The tools required depend on the complexity of the map and mapping process. Three main alternatives include the use of simple multipurpose tools like Excel, dedicated map maintenance applications and/or custom built applications.

Develop the map

The process of map development needs to be done in a controlled manner and involves:

- ◆ Data preparation
- ◆ Algorithmic mapping (where possible and deemed to be safe)
- ◆ Human mapping, including map verification
- ◆ Publication
- ◆ Life cycle management

Checks and balances should be used at each stage to ensure that the process is technically accurate and any maps created should be checked either using a map verification process or by parallel independent mapping. Once maps are created and published a cycle of testing should be performed to validate that the results obtained through the use of the maps to transform or migrate data meets the defined requirements.

Use the maps

Having created the maps to or from SNOMED CT, there are various aspects to consider when using the maps to migrate or transform clinical data. The actual specific use case needs to influence the final requirements of how this is undertaken. Specific attention needs to be paid to reporting, interoperability and data migration. The more common use cases are:

- ◆ Identifying records to include in reports.
- ◆ Transforming the original clinical data to meet the messaging specification for sending data to another system.
- ◆ Migrating existing clinical data either because a system is being upgraded to use SNOMED CT or to introduce a new system that uses SNOMED CT.

Throughout the use of maps, there are fundamental principles and best practices that should be adhered to including:

- ◆ Consider all design elements of the system.
- ◆ Maintain an audit trail for transformation or migration.
- ◆ Manage future amendments to the mapping table.
- ◆ Ensure visibility of original text of mapped items (as recorded prior to mapping).
- ◆ Support clinical safety.



Review activity

As with any process, a post-activity review stage is recommended. This should ensure that:

- ◆ Appropriate lessons are learnt and documented and thus can be referred to in any future mapping activity.
- ◆ Issues that can be addressed within the current mapping are appropriately managed. For example, where the maps are being used for transformation then lessons learnt should be fed back into the process to improve the quality of the transformed data. The same is true in a data migration scenario where maps are reapplied subsequent to the initial migration.

13. RELEASE SCHEDULE AND FILE FORMATS

This section provides an overview of:

- ◆ Release schedule and process
- ◆ Release files and formats
- ◆ Release types

Why is this important?

SNOMED CT is distributed to IHTSDO Members and Affiliate Licensees as a set of downloadable files. Those wishing to implement SNOMED CT in software applications should understand the release schedule and the structure and content of the release files. Users should be aware that regular updates of SNOMED CT are made available and should be used in their systems to benefit from continuous improvements to coverage and quality.

What is this?

Release schedule and process

The SNOMED CT International Edition is currently released twice a year on the 31st of January and the 31st of July. The release files are made available to Members in advance of the formal release date and Affiliate Licensees gain access either through their National Member or via the IHTSDO Affiliate Licensing system. Many IHTSDO Members supplement the International Edition with releases of their national Extension. The Extensions may be released at the same time as the International Edition but in some cases are released on different dates and at different intervals.

Release files and formats

Release Format 2 (RF2) is the primary format used for SNOMED CT release files. This format includes valuable additional data that was not supported by the earlier format.

The SNOMED CT International Edition is released as a set of files:

- ◆ The release files are:
 - Tab-delimited text files
 - Encoded in accordance with the Unicode UTF-8 specification (which supports a wide range of characters, symbols and accented characters)
- ◆ There are individual files with specified columns for each of the core components of SNOMED CT:
 - Concepts
 - Descriptions
 - Relationships

All components in the release files have permanent unique SNOMED CT Identifiers.
- ◆ There are also individual files with specified columns for each type of Reference Set
 - These files contain essential information about language preferences, subsets, maps and metadata to support technical implementations

The same file formats are also used for SNOMED CT Extensions.

Release types

The RF2 specification provides a history tracking mechanism within the distributed files. This enables different release types to be provided using the same file format and utilizing this mechanism to optimize installation and updating.

Full Release: A 'Full' release contains every version of every component that has ever been released prior to or in the specified Edition. This release provides a full historical record and can be used to obtain views of the state of any component at any point in time since its first release. The 'Full' release is the easiest way to install and initialize SNOMED CT. However the files are large and in each release only a small fraction of the content will have changed.

Delta Release: A 'Delta' release contains only those component versions created, inactivated or changed since the previous release. The 'Delta' release is much smaller than a 'Full' release and is ideal for updating a 'Full' release of the previous version. Adding a 'Delta' release to the previous version's 'Full' release will update the installation to a 'Full' release of the current Version.

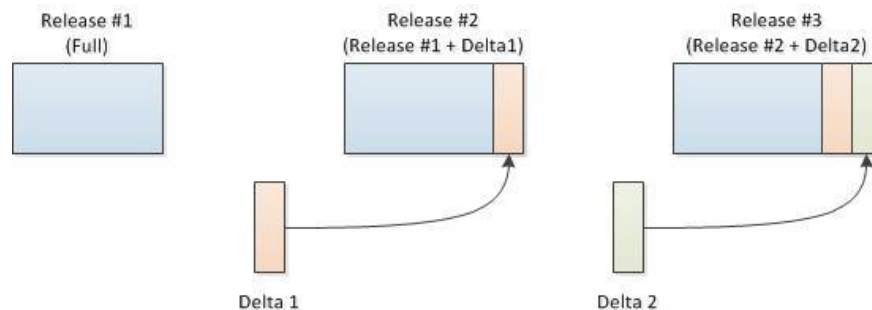

Snapshot Release: A 'Snapshot' release contains the most recent version of every component released up to the time of the snapshot. The version of each component contained in a snapshot is the most recent version of that component at the release time. The 'Snapshot' release is useful for a simple installation but does not provide a history or retrospective view of the terminology.

There are valid use cases for each Release Type. Each International release will incorporate all three of these Release Types, allowing users to choose the most appropriate format for their needs. Extensions should always be available as a full release and other Release Types may also be made available.

Relationships between files

In Snapshot Release files

- ◆ Each SNOMED CT concept is held as a single row in the concept file. Each row represents a clinical concept.
- ◆ Each description is held as a single row in the description file, and is associated with a single concept.
- ◆ Each relationship, from a source concept to a destination concept, is held as a single row in the relationship file. Each row also refers to the concept that represents the relationship type

In Full Release files, concepts, descriptions and relationships may be represented by more than one row. In this case each row represents the state of the component at a stated point in time.

14. IHTSDO – THE ORGANISATION BEHIND SNOMED CT

This section provides an overview of:

- ◆ The International Health Terminology Standards Development Organisation (IHTSDO)
- ◆ Members of IHTSDO
- ◆ IHTSDO Standing Committees and Working Groups
- ◆ National Release Centers

Why is this important?

IHTSDO is the international not-for-profit Organisation that owns and administers SNOMED CT, and owns the rights to SNOMED CT and related terminology standards.

What is this?

IHTSDO is an association governed by a General Assembly that contains one representative of each of its national Members.

IHTSDO seeks to improve the health of humankind by fostering the development and use of suitable standardized clinical terminologies, notably SNOMED CT, in order to support safe, accurate, and effective exchange of clinical and related health information. The focus is on enabling the implementation of semantically accurate health records that are interoperable.

The purpose of IHTSDO is to develop, maintain, promote and enable the uptake and correct use of its terminology products in health systems, services and products around the world, and undertake any or all activities incidental and conducive to achieving the purpose of the Association for the benefits of the members.

Members of IHTSDO

IHTSDO now has more than 25 national Members. An updated list of the current members can be found at the IHTSDO web page (www.ihtsdo.org/members). Members of the IHTSDO can be either an agency of a national government or another body endorsed by an appropriate national government authority within the country it represents. The IHTSDO welcomes new Members.

The IHTSDO Members pay a fee, based on national wealth, to the IHTSDO which gives them the right to a seat on the General Assembly. IHTSDO does not charge Affiliate Licensees for use of the SNOMED CT International Edition within Member countries. Licensing is also free in the poorest countries and for certain approved public-good uses in other countries. In other cases, low-cost per-institution charges apply to the use of SNOMED CT in operational systems involved in data creation and/or analysis. All use of SNOMED CT is subject to the acceptance of the terms of the SNOMED CT Affiliate License agreement (www.ihtsdo.org/license.pdf) and the terms of sublicenses issued to end-user organizations by Affiliate Licensees. Members may also impose additional conditions on use of SNOMED CT within their countries. For example, a Member may require licensees to support and include its National Extension in its implementations.

IHTSDO governance

The highest governance body of the IHTSDO is the General Assembly which includes a formally appointed representative of each IHTSDO Member. The General Assembly appoints a Management Board which directs the Association and has responsibility for key business decisions. The Chief Executive Officer (CEO) is appointed by the Management Board and has day-to-day responsibility for the conduct of the business. The CEO is supported by a team of senior staff responsible for particular lines of business.

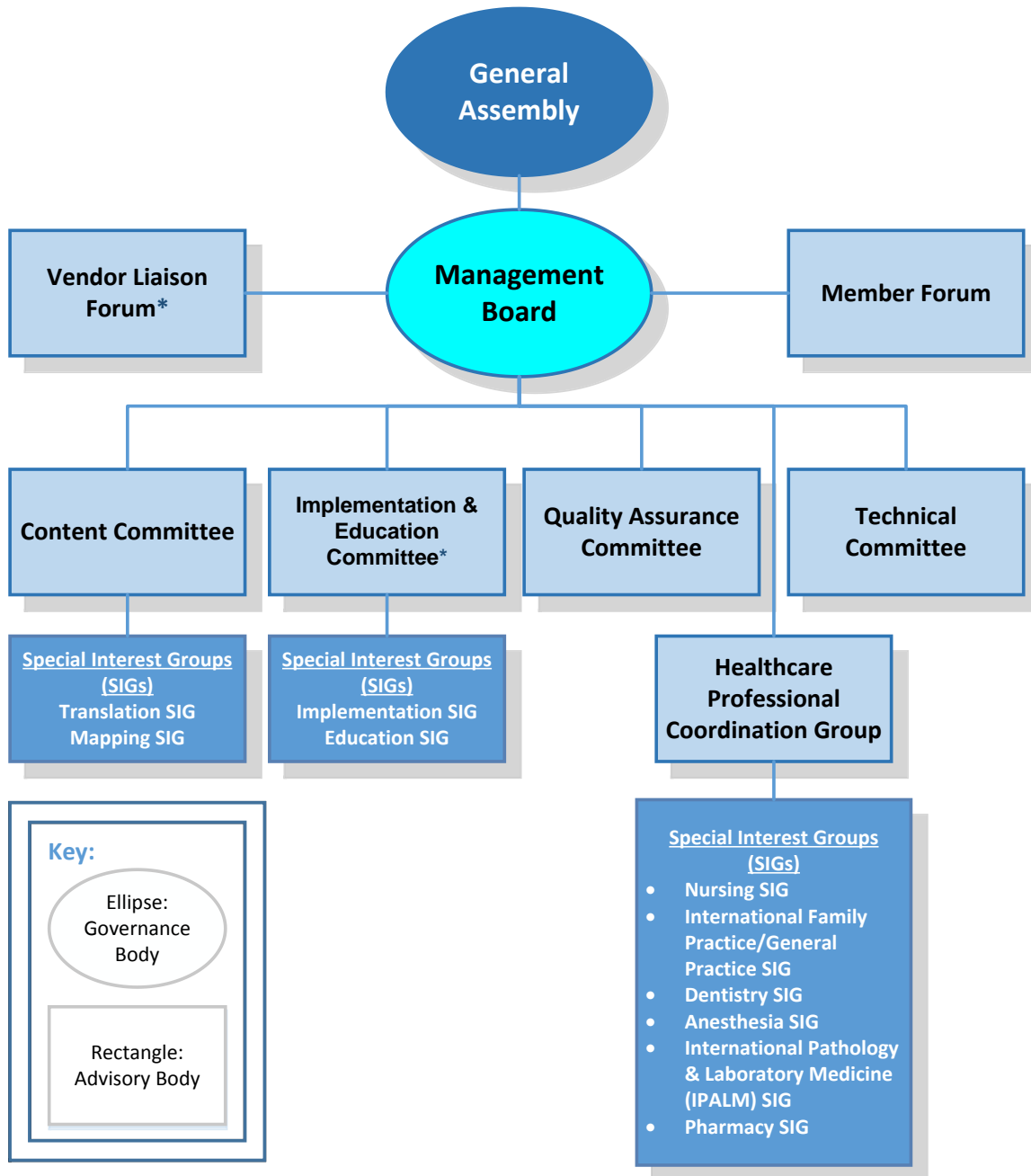

Updated 13 December 2013

Note* Diagram includes provisional changes to the names of the Affiliate Forum (shown as Vendor Liaison Forum) and the Implementation and Innovation Committee (shown as Implementation and Education Committee) which are expected to be formally adopted in 2014)



IHTSDO advisory bodies

Standing Committees

The IHTSDO has four Standing Committees which provide advice to the Management Board. Committee members are elected by the General Assembly. They meet face to face twice a year, and between those meetings have regular conference calls. Meetings of these committees are generally open to observers.

Content Committee: Is responsible for providing advice on issues related to the definition and maintenance of the clinical content and structure of SNOMED CT and its related standards.

Implementation and Education Committee: Is responsible for providing advice, assistance and education to enable effective practical implementation of SNOMED CT in ways that aid the management of clinical information and assist clinical decision making.

Quality Assurance Committee: Is responsible for the development and quality assurance of SNOMED CT and its related standards and the Association's other Terminology Products in harmony with proper respect to external standards.

Technical Committee: Is responsible for focusing on technology related issues relating to the use and application of SNOMED CT, the fitness for purpose of frameworks and tools adopted in the application of SNOMED CT.

Working Groups

Working groups include

- ◆ Special Interest Groups (SIGs) which are open forums that examine issues on particular topics or healthcare specialty areas; and
- ◆ Project Groups which have defined time-limited objectives.

There are two distinct types of Special Interest Group

- ◆ Topic Based SIGs cover a general topic area (e.g. implementation, translation) and report to one of the Standing Committees; and
- ◆ Professional Specialty SIGs focus on requirements of a particular clinical discipline or specialty (e.g. Nursing, Anesthesia). These SIGs report to the Healthcare Professional Coordination Group which includes the chairs of each of the professional SIGs.

To join a Special Interest Group or to access information about one of the other groups you need to create an account on the IHTSDO Collaborative Space (see www.ihtsdo.org/collabnet).

National release centers

IHTSDO Members undertake a range of activities related to their involvement in the IHTSDO and their role in distributing, extending and supporting the use of SNOMED CT in their country. The Organisation or agency that coordinates this role in each country is referred to as a National Release Centre (NRC). National Release Centers provide a single point of contact for communications with IHTSDO and other IHTSDO Members. Within their own countries, NRCs manage the use of SNOMED CT and communicate with a range of stakeholders, including SNOMED CT Affiliate Licensees, healthcare institutions, clinical groups and end users.

15. LEARNING MORE ABOUT SNOMED CT

The Starter Guide is intended as a practical and useful starting point from which anyone with a general interest in healthcare information can begin learning about SNOMED CT. It provides a broad overview of SNOMED CT from which to start a more detailed exploration of areas that are of particular interest.

IHTSDO provides many other materials on its website that you are welcome to explore. These include specifications and more detailed guides on which this Starter Guide is based. In addition there are FAQs, “how to” guides and brief summaries of benefits. Training slide sets, recorded tutorials and online self-assessment tests are also available and these resources are set to grow significantly during 2014.

The website also provides access to presentations and tutorial slide sets from the annual SNOMED CT Implementation Showcase events held over the last three years.

Topic	Key reference
Information about IHTSDO Find out more about the Organisation, members, committees, special interest groups, newsletter and events.	www.ihtsdo.org <ul style="list-style-type: none"> • www.ihtsdo.org/about-ihtsdo • www.ihtsdo.org/members • www.ihtsdo.org/committee • www.ihtsdo.org/sig • www.ihtsdo.org/newsletter.pdf • www.ihtsdo.org/events
General information about SNOMED CT Materials include a benefits paper, a very short introductory presentation and information about licensing.	www.snomed.org <ul style="list-style-type: none"> • www.snomed.org/benefits.pdf • www.snomed.org/snomedintro.pdf • www.snomed.org/license
Documentation Library Access to detailed documents, including the Technical Implementation Guide, Editorial Guide and FAQs.	www.snomed.org/doc
SNOMED CT Browsers A range of online and offline tools to search SNOMED CT content.	www.snomed.org/browsers
SNOMED CT in action Examples of how SNOMED CT is being used around the world.	www.snomedinaction.org
SNOMED CT Starter Guide The latest version of this guide. (The guide can also be found in the Documentation Library - see above).	www.snomed.org/snomedct_starter.pdf
SNOMED CT E-Learning Center	www.snomed.org/elearning
SNOMED CT Online Assessment Tests	www.snomed.org/challenge

